

Molift RgoSling

molift[®]
by Etac

User Manual - Bruksanvisning - Brukermanual - Brugervejledning - Käyttöopas -
Bedienungsanleitung - Gebruikershandleiding - Manuel d'utilisation - Manuale
per l'utente - Manual de usuario

BM40699 Rev. A 2021-02-23

RgoSling Comfort Highback

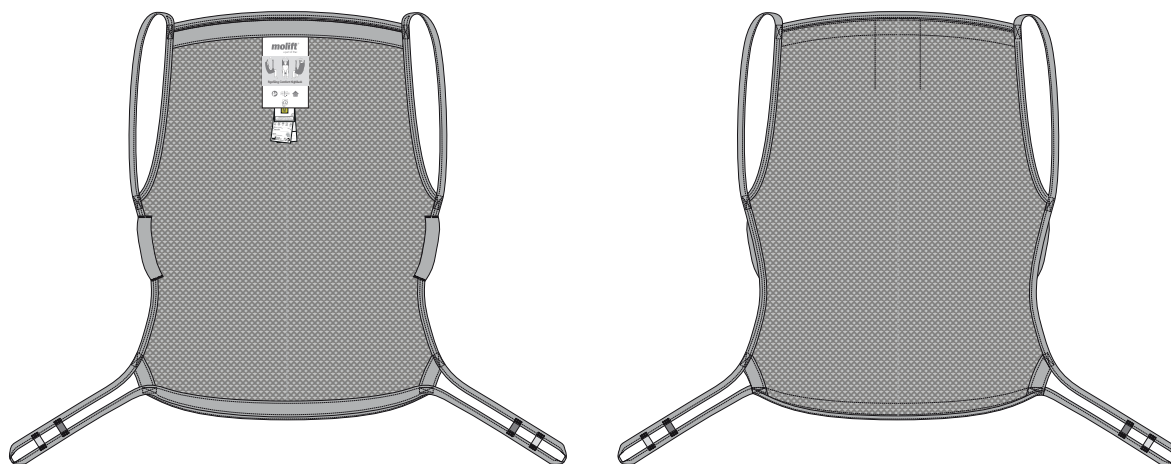

MD

CE



Contents

User manual - English -	4
Bruksanvisning - Svenska -	14
Brukermanual - Norsk -	24
Brugervejledning - Dansk -	34
Käyttöohje - Suomi -	44
Gebrauchsanweisung - Deutsch -	54
Handleiding - Nederlands -	64
Manual d'utilisation - Français -	74
Manual utente - Italiano -	84
Manual de usuario - Español -	94

English manual

Content

General.....	4
Test and Warranty	4
Safety Precautions	5
Inspection.....	5
Periodic inspection.....	5
Description.....	6
Etac Molift RgoSling Comfort HighBack...	6
Care/Washing	6
Sling application, lying	8
Lifting	9
Transfer.....	9
Sling adjustment and checkpoints.....	10
Removing sling.....	11
Combination list.....	12
Slingguide	12
Troubleshooting	13

Test and Warranty

 this product is CE-marked.

Etac Molift slings are tested by accredited test institutes and comply with the standards outlined in the Medical Devices Directive for Class 1 products MDR (EU) 2017/745. The slings fulfil the requirements specified in the EN ISO 10535 standard.

Warranty: Two years for material and manufacturing defects with correct use.

For more details on Etac Molift's range of slings and lifts visit www.molift.com

General

Thank you for choosing a sling from Molift by Etac.

The manual must be read thoroughly to avoid injuries or damage when handling and using the product.

In this manual the user is the person being lifted. The assistant is the person operating the sling.



This symbol appears in the manual together with text. It indicates a need for caution when the safety of the user or assistant may be at risk

Etac continuously makes improvements to the products. We therefore reserve the right to modify the products without prior notice.



Visit www.molift.com for more information, advice and any documentation updates.

We cannot be held responsible for any printing errors or omissions.

Safety Precautions

To be aware of



The manual for both lift and sling must be read thoroughly before use to avoid injury when handling and using the product.

It is important that the sling has been tested with the individual user and for the intended lifting situation. Make a decision on whether one or more assistants are required.

Plan the lifting operation in advance to ensure that it is as safe and smooth as possible. Remember to work ergonomically.

Assess the risks and take notes. You as a carer are responsible for the safety of the user.



Never lift a user higher from the starting point than what is necessary to carry out a lift. Never leave the user unattended in a lifting situation



Always check

- that the user has the required ability for the sling in question
- that the model, size and material are suitable
- that the sling is suitable for the lift/suspension to be used.
- It is important to check that the strap loops are correctly attached to the suspension hooks before lifting the user.
- Make sure wheels on the wheelchair, bed or bunk are locked when necessary during the transfer process.

Inspection

The sling must be inspected regularly, preferably prior to each lifting operation but especially after it has been washed.

- Check to ensure that there is no wear or damage to seams, fabric, straps and loops.



Never use a faulty or damaged sling as it can break and cause personal injury. Destroy and discard damaged and old slings



The sling should not be stored in direct sunlight.

Periodic inspection

Periodic inspection must be carried out at least

every 6 months. More regular inspection may be required if the sling is used or washed more often than is normal. See the periodic inspection form at www.molift.com

Description

Etac Molift supplies a wide selection of slings for different types of transfers. The Molift RgoSling is designed to distribute even weight and pressure to make it as comfortable as possible.

The sling's upper suspension straps are slidable allowing the sling to find an even balance during the entire transfer. This provides the user with great comfort and a pleasant lift

There is a guide handle to help position users in the correct sitting position and it is used only when users are in lifting mode.

The Molift RgoSling is developed to be combined with a 4-point suspension but the sling also works with a 2-point suspension. See the combination list for the correct sling and suspension combination.

The Molift RgoSling Comfort Highback is available in sizes S – L, in polyester mesh.

Molift RgoSling Comfort HighBack

Is an unpadded sling that shapes itself to the body. The sling is intended to remain beneath the user after the lift and the move have been completed. It is made from a polyester mesh material that allows body moisture and heat to pass through. The sling can only be applied with the user in lying position. The arms is placed inside the sling, and the sling provides a comfortable seating position with full support for head and body.

The product has an expected service life of 1 to 5 years under normal use. The service life of the product varies depending on usage frequency, materials, loads and how often it is washed.

- A1. Product label
- A2. (01) EAN-code
xxxxxxxxxxxxxxx
(21) Serial number
xxxxxxx
- A3. QR-code
- A4. Label: Periodic inspection
- A5. Label: User name
- A6. Upper strap loops
- A7. Guide handle, side
- A8. Lower strap loops
- A9. Symbol: Read the manual before use
- A10. Symbol: Max. user weight
- A11. Symbol: This side of the product is turned upward and outward
- A12. Symbol: Fold out for more information

Care/Washing

Read the care instructions on the product.

1. Water washable slings can be washed at temperatures ranging from 60 to 85° C degrees.
-  Washing at higher temperatures wears out the material faster.
2. Tumble drying, max 45° C.
Can be autoclaved at 85° C for 30 minutes
 3. Do not dryclean.
 4. Do not bleach.
 5. Do not iron.

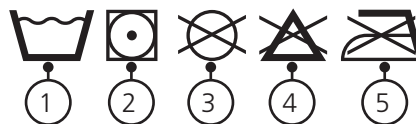

Symbols:



Manufacturer



Date of manufacture.
YYYY-MM-DD
(year/month/date)



CE marked



Refer to user manual



This way up, this side is outside



max 255 kg max 560 lbs Max user weight



Medical Device

A

RgoSling Comfort HighBack

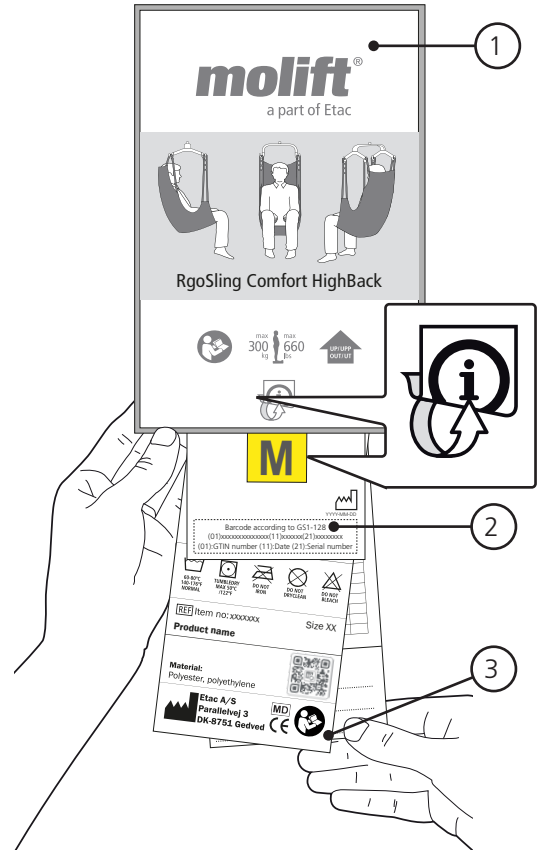
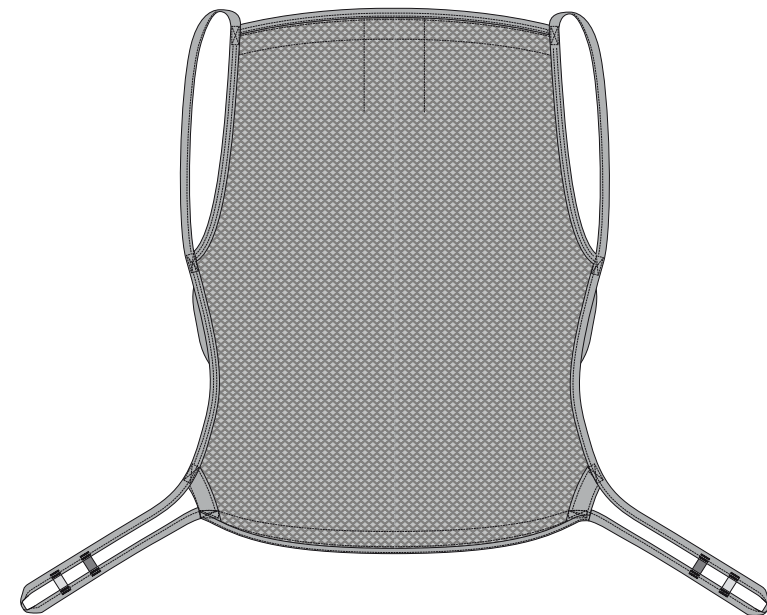
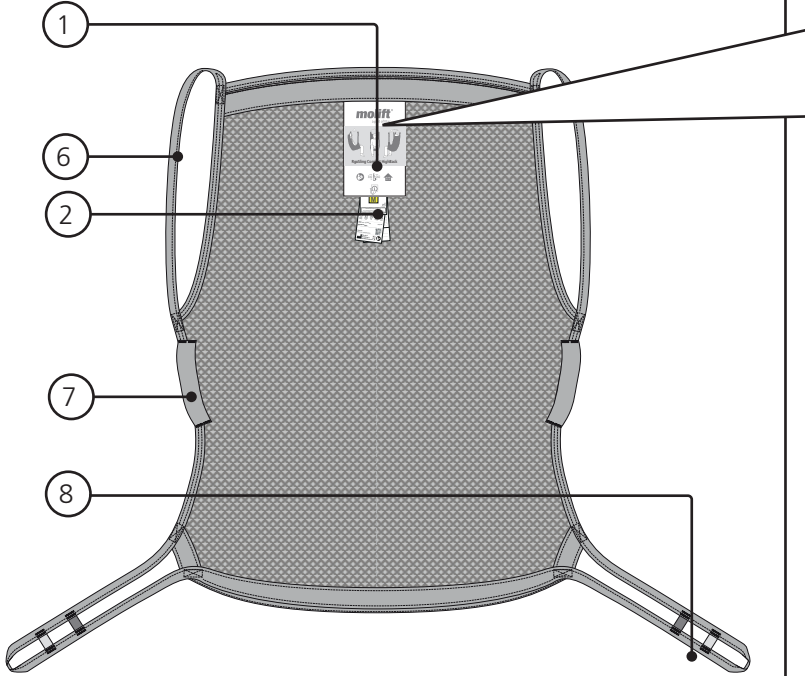

Etac Molift RgoSling

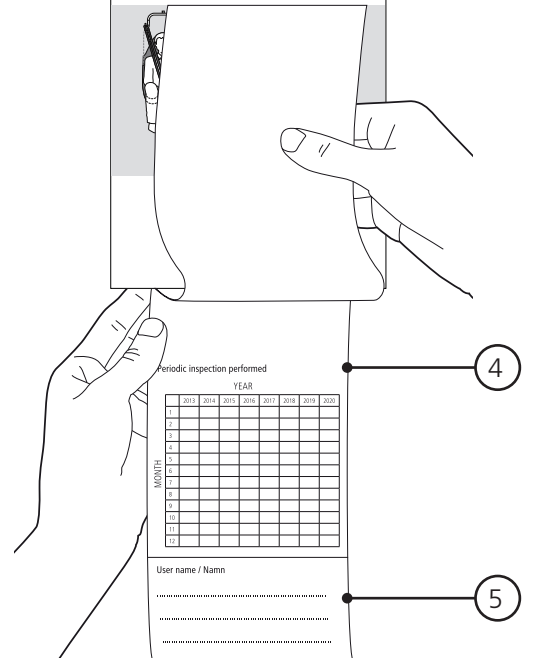



9

max 300 kg



max 660 lbs

10



UP/UPP
OUT/UT

11



12

B

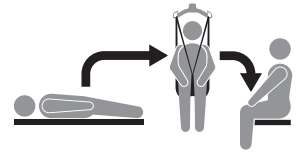

Sling application

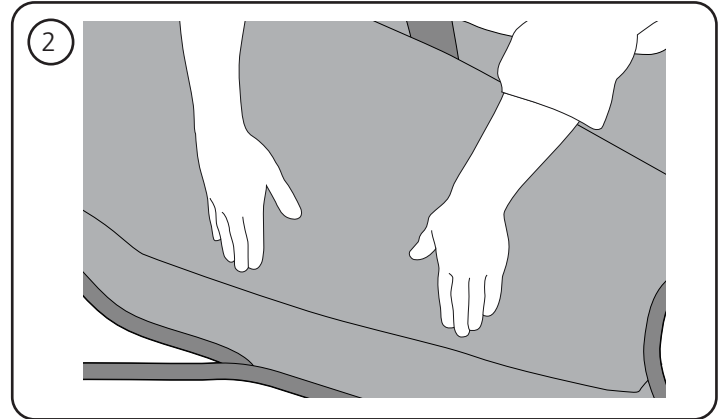
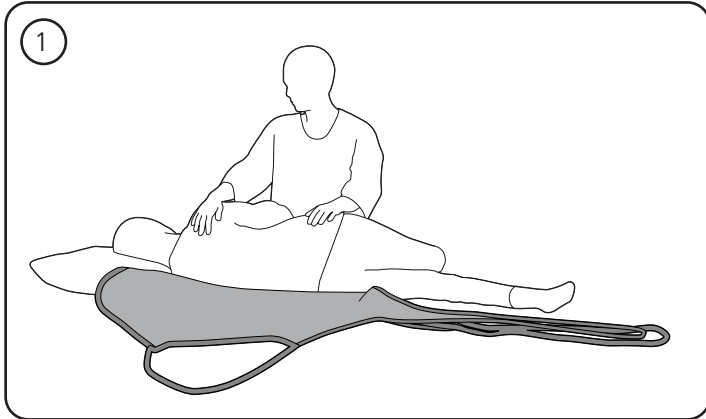

B1. Turn the user towards you until he/she is lying safely on their side. Fold the sling in the middle and position it behind the user's back.

B2. Then turn the user over on the opposite side and pull the sling forward. Make sure the user is positioned at the centre of the sling. If the bed has a bed back support it can be used. Be careful when repositioning the user over to the other side. Make sure he/she does not flip over and rolls out of bed.

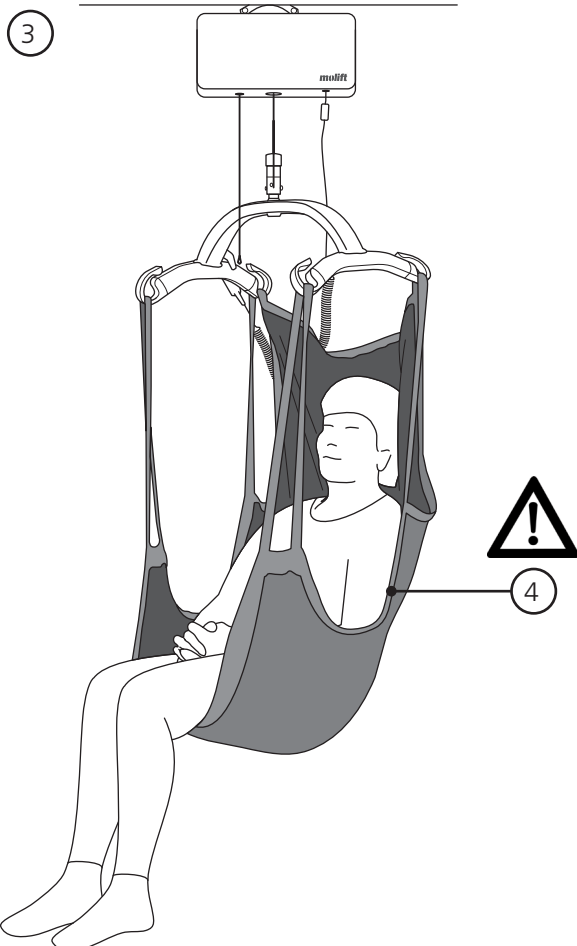

B3. Do not cross the legsupport. If the user has instability in the torso, or is spastic (involunteer musclecontractions) it may cause a risk for him/her to fall headlong out of the sling. In this case we recommend as much reclining position as possible, using the inner connection points on the lower lifting straps.

B4. There is a guide handle to help position users in the correct sitting position and it is used only when users are in lifting mode. This is not a strap loop for lifting!

Lifting

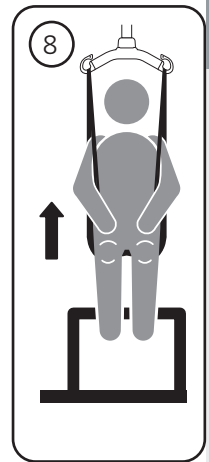
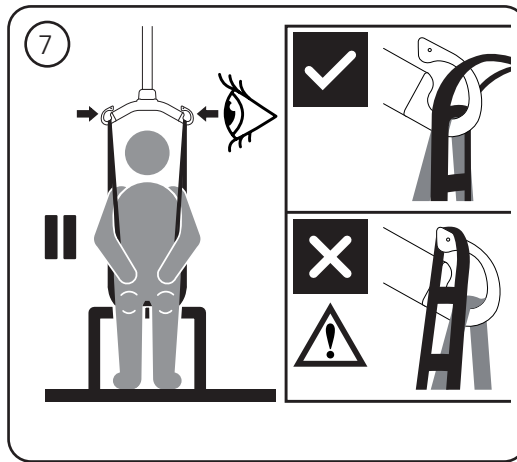
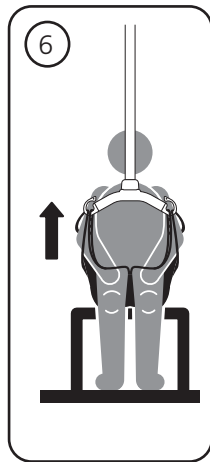
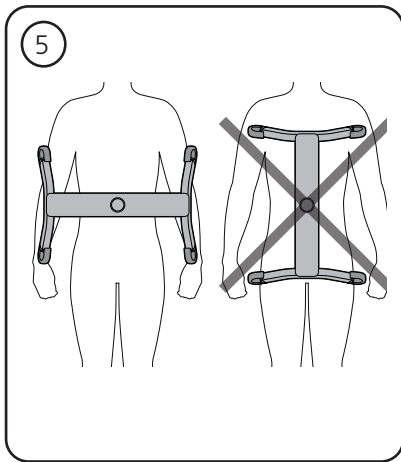

- B5. The suspension must always be positioned across the user, to prevent the user from unintentionally sliding out of the sling.
- B6. Suspend the sling in the suspension's hooks.
- B7. Stretch the sling straps without lifting the user. Check that the sling is correctly fitted around

- the user and that the strap loops are correctly fitted to the suspension hooks.
- B8. Lift the user no higher than necessary. Remember that wheels on a mobile lift must NOT be locked.

Lowering into sitting

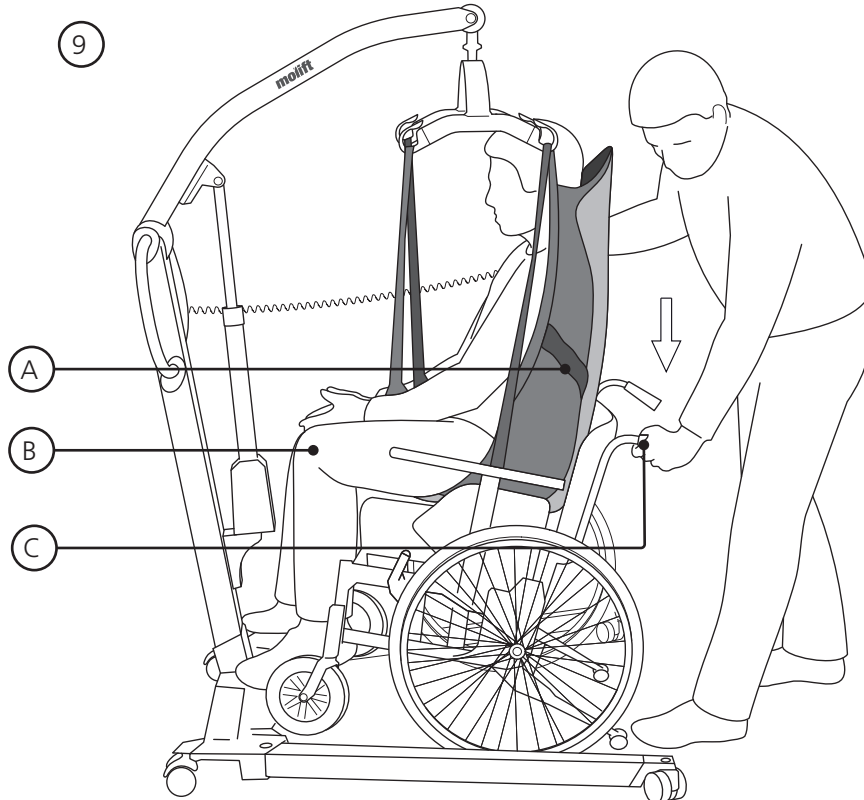

- B9. When transferring the user into sitting, the following techniques can be used when lowering the user as far back into the seat as possible:
 - A. Position the user with the help of the steering handle
 - B. Push gently on the users knees
 - C. Tilt the seat backwards

C

Sling adjustment and checkpoints

RgoSling Comfort HighBack

- C1. Make sure suspension is away from the users face
- C2. Make sure head support is not too low, sling should be placed higher than users head.
- C3. Make sure sling is placed well under thighs.
- C4. Do not cross lower strap loops

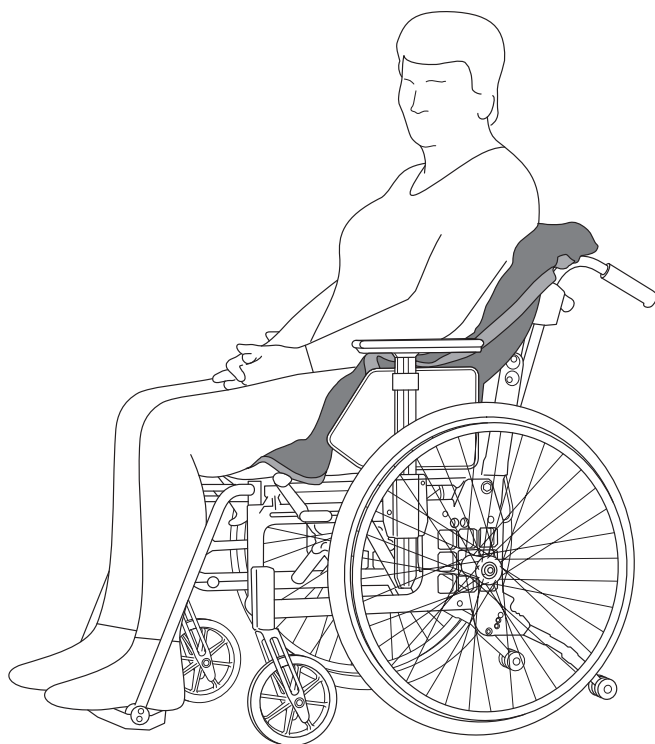
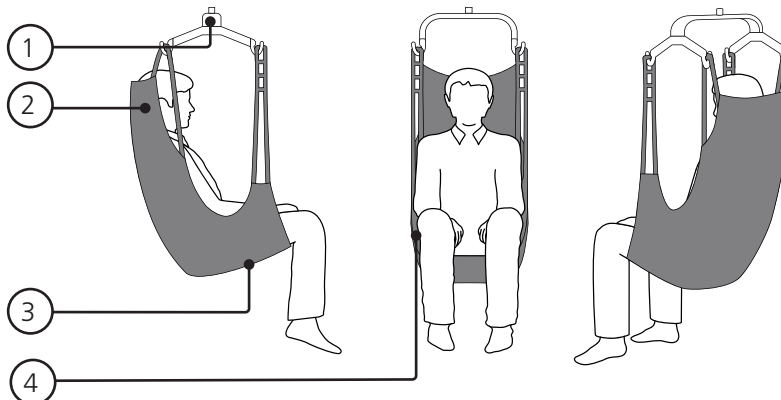

- C5. The sling is supposed to remain under the user after transfer.



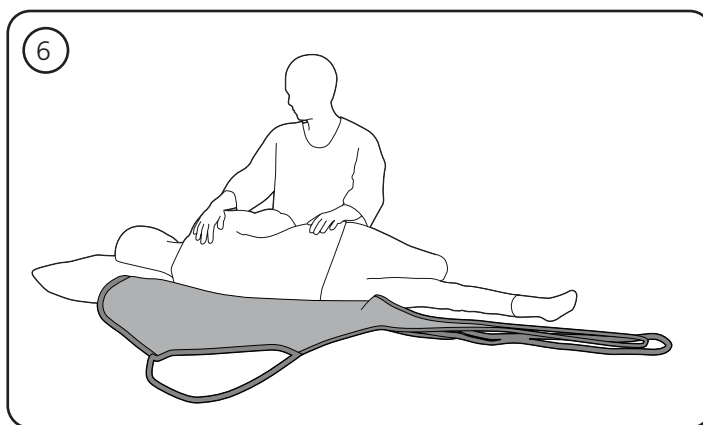





Removing Sling

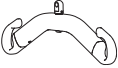
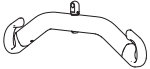
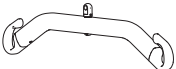

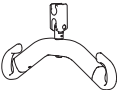
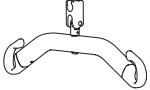
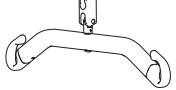



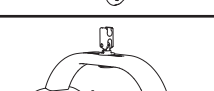

C6. Release the loops from the suspension. Turn the user towards you until he/she is lying safely on their side. Fold the sling in the middle and position it behind the user's back. Then turn the user over on the opposite side

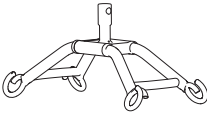
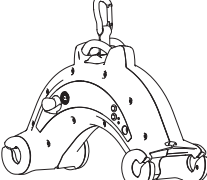
and pull the sling away. Be careful when repositioning the user over to the other side. Make sure he/ she does not flip over and rolls out of bed.

Combination list

Suspension		RgoSling Comfort HighBack		
		S	M	L
Mover 180				
	2-pt Small	✓		
	2-pt Medium	✓	✓	
	2-pt Large		✓	✓
	4-pt Medium	✓	✓	✓
	4-pt Large		✓	✓
Mover 205				
	2-pt Small	✓		
	2-pt Medium	✓	✓	
	2-pt Large		✓	✓
	4-pt Medium	✓	✓	✓
	4-pt Large		✓	✓
Mover 300				
	4-pt Medium	✓	✓	✓
	4-pt Large		✓	✓
Partner 255				
	4-pt Medium	✓	✓	✓
	4-pt Large		✓	✓

Suspension		RgoSling Comfort HighBack		
Smart		S	M	L
	4-pt Medium	✓	✓	✓
Nomad				
	4-pt Medium	✓	✓	✓
Nova				
	2-pt Small	✓		
	2-pt Medium	✓	✓	
	2-pt Large		✓	✓
	4-pt Medium		✓	✓
	4-pt Large			✓

Slingguide

The size to choose depends partly on the user's weight, function and body circumference/size. SWL (Safe Working Load) is 300 kg.

Troubleshooting

Symptom	Possible Cause/Action
The sling does not fit the user.	Wrong sling size. Try other size.
	The sling is too small when the leg supports do not reach halfway around the inner thigh and the suspension is too close to the user's face. Try other size.
	The sling is not correctly positioned. Pull the sling enough down at the back when fitting it.
All the straps does not lift at the same time.	If the sling straps lift unevenly, it means that the sling can slide up at the back which can lead to the user sliding down in the opening in the sling. Make sure that the leg supports are positioned correctly on the thighs.

EN

SV

NO

DA

FI

DE

NL

FR

IT

ES

Manual Svenska

Innehåll

Allmänt.....	14
Testning och garanti.....	14
Försiktighetsåtgärder.....	15
Tillsyn.....	15
Periodisk inspektion.....	15
Beskrivning.....	16
Etac Molift RgoSling Comfort HighBack.....	16
Skötsel / tvätt.....	16
Applicering av selen i liggande position....	18
Lyft.....	19
Nedsänkning till sittande position.....	19
Justering av selen samt kontrollpunkter....	20
Ta av sele.....	21
Kombinationslista.....	22
Selguide.....	22
Felsökning.....	23

Allmänt

Tack för att du valt en lyftsele från Molift by Etac.

För att undvika skador vid hantering och användning skall denna manual läsas igenom.

I den här manualen är Brukaren den person som lyfts. Assistenten är den person som applicerar selen.



Den här symbolen förekommer i manualen tillsammans med text. Den indikerar behov av försiktighet när brukarens eller hjälparens säkerhet kan äventyras.

Etac förbättrar fortlöpande sina produkter. Vi förbehåller oss därför rätten att ändra produkterna utan föregående meddelande.



Besök www.molift.com för mer information, råd och eventuella uppdateringar av dokumentation.

Vi reserverar oss för feltryck och ofullständigheter.

Testning och garanti

CE Denna produkt är CE-märkt.

Etac Molifts lyftselar är testade av ackrediterade testinstitut och uppfyller kraven enligt standarderna i Medicintekniska direktivet för klass 1-produkter MDR (EU) 2017/745. Selarna uppfyller kraven enligt EN ISO 10535.

Garanti: Två år för material och tillverkningsfel vid korrekt användning.

Mer information om Etac Molifts sortiment av selar och lyftar, gå in på www.molift.com.

Försiktighetsåtgärder



För att undvika skador vid hantering och användning ska alltid manual för både lyft och lyftsele läsas igenom noga före användning.

Det är viktigt att selen är utprovad för den enskilda brukaren och den avsedda lyftsituationen. Gör en bedömning om det behövs en eller flera assistenter.

Planera lyftmomentet före lyft, så att det sker så tryggt och smidigt som möjligt. Tänk på att arbeta ergonomiskt.

Gör en riskbedömning och dokumentera. Som vårdgivare är du ansvarig för brukarens säkerhet.



Lyft aldrig en brukare högre från underlaget än vad som är nödvändigt för lyftets genomförande. Lämna aldrig en brukare utan tillsyn i en lyftsituation



Kontrollera alltid:

- att brukaren har den funktion som krävs för den aktuella selen
- att modell, storlek och material passar
- att selen passar för den lyft/lyftbygel som ska användas.
- Det är viktigt att kontrollera att bandöglorna sitter rätt på upphängningskrokarna innan brukaren lyfts från underlaget.
- Se till att hjulen på rullstol, säng, brits etc. är låsta när så krävs under förflyttningen.

Tillsyn

Selen ska kontrolleras regelbundet, helst före varje användning, men var särskilt noggrann efter att den tvättats.

- Kontrollera så att inga förslitningar eller skador finns på sömmar, tyg, band och öglor.



Använd aldrig en trasig eller skadad lyftsele, den kan gå sönder och orsaka personskador. Kassera skadade eller slitna selar.



Selen bör ej förvaras i direkt solljus.
Periodisk inspektion

Periodisk inspektion

Periodisk inspektion skall utföras minst var 6:e

månad. Tätare inspektioner kan krävas om selen används eller tvättas oftare än normalt. Se protokoll för periodisk inspektion på www.molift.com

EN

SV

NO

DA

FI

DE

NL

FR

IT

ES

Beskrivning

Etac Molift erbjuder ett brett sortiment av lyftselar för olika slags förflyttningar. Etac Molift RgoSling är utformad för att ge en jämn vikt- och belastningsfördelning för att vara så bekväm som möjligt.

Selens övre upphängningsband kan glida i bygel. Lösningen ger en jämn viktfördelning och bättre balans under hela lyftrörelsen. Lyftet blir därmed behagligt för brukaren.

För att positionera brukaren till rätt sittande position finns det styrhandtag som används endast när brukaren är i lyft läge.

Etac Molift RgoSling är utvecklad för att kombineras med 4-punktsbygel men selen fungerar även bra med 2-punktsbygel. Se kombinationslista för korrekt kombination av sele och bygel.

The Molift RgoSling Comfort Highback är tillverkad i nätpolyester och finns i storlek S – L.

Molift RgoSling Comfort HighBack

är en opolstrad lyftsele som formar sig efter kroppen. Lyftselen är avsedd att lämnas kvar under brukaren efter lyft till sittande. Selen är tillverkad av polyesternät material som möjliggör att kroppsfukt och värme att ventileras bort. Lyftselen kan endast placeras/tas bort när brukaren är i liggande ställning. Armarna placeras innanför selen. Selen ger en bekväm sittställning med fullt stöd för huvud och kropp

Produkten har en förväntad livslängd på 1-5 år vid normal användning. Livslängden på produkten varierar beroende på användningsfrekvens, material, belastning samt hur ofta den tvättas.

- A1. Produktetikett
- A2. (01) EAN-kod
xxxxxxxxxxxxxxxx
- (21) Serienummer
xxxxxxx
- A3. QR-kod
- A4. Etikett: Periodisk inspektion
- A5. Etikett: Brukarnamn
- A6. Övre bandöglor
- A7. Styrhandtag sida
- A8. Nedre bandöglor
- A9. Symbol: Läs manual före användning
- A10. Symbol: Max brukarvikt
- A11. Symbol: Denna sida av produkten vänds uppåt och utåt
- A12. Symbol: Veckla ut för mer information

Skötsel / tvätt

Läs skötselinstruktionen på produkten.

1. Selar med angiven vattentvätt kan tvättas med temperatur från 60 till 85 °C.



Vid tvätt i högsta temperatur sker en snabbare förslitning av materialet.

2. Torktumling max 45 °C.
Kan autoklaveras vid 85 grader i 30 min
3. Får inte kemtvättas.
4. Får inte klorblekas
5. Får inte strykas.

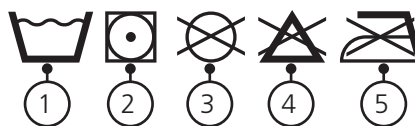

Symboler:



Tillverkare



Denna sida upp, denna sida utåt



Tillverkningsdatum.
ÅÅÅÅ-MM-DD
(år/månad/dag)



Max. brukarvikt
(säker arbetsbelastning)



CE-märkt



Medicinteknisk produkt



Se manual

A

RgoSling Comfort HighBack

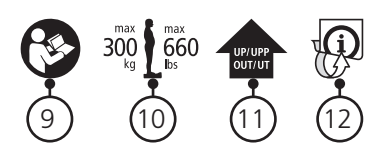
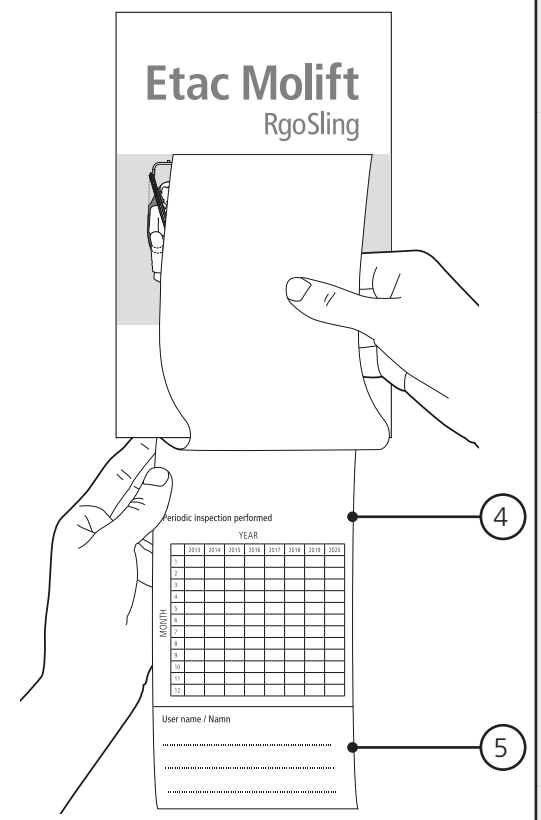
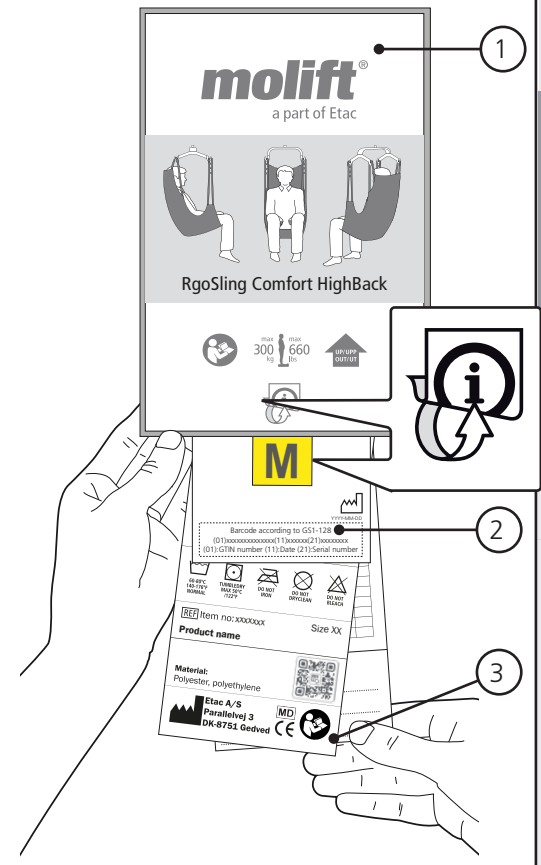
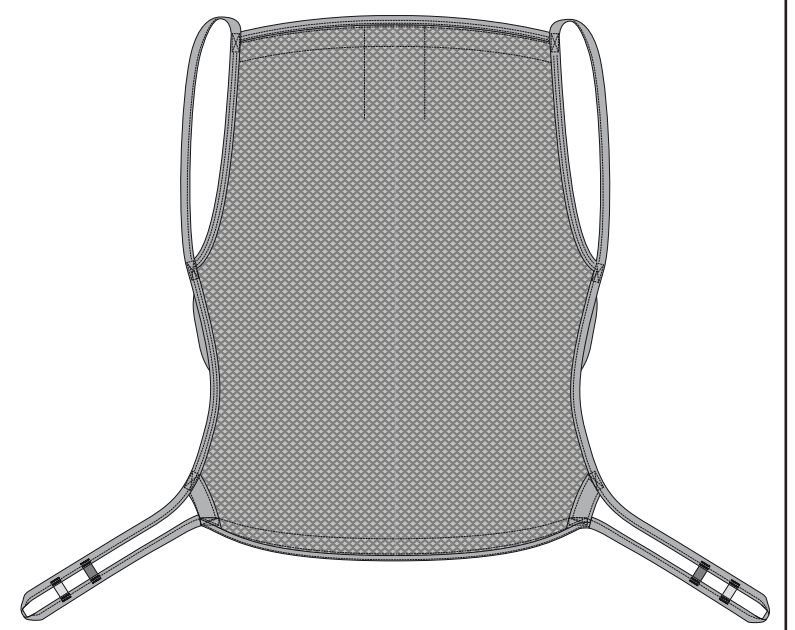
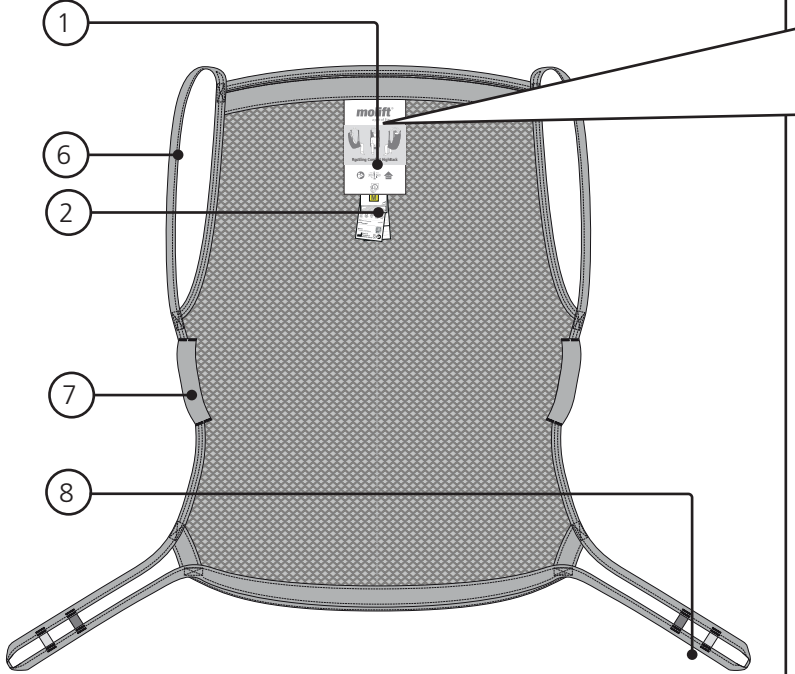

B

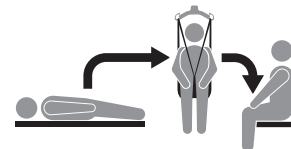

Sling application

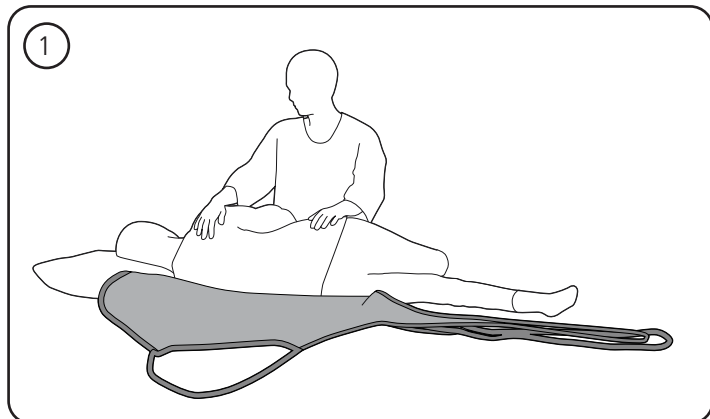

B1. Vänd brukaren mot dig så att han/hon ligger på sidan i en säker position. Vik lyftselen på mitten och placera den bakom brukarens rygg.

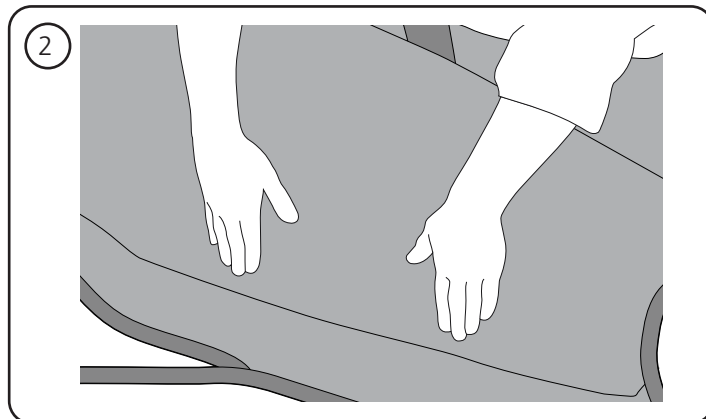

B2. Vänd sedan brukaren över på motsatt sida och dra fram lyftselen. Se till att brukaren placeras mitt på lyftselen. Om sängen har ett sängryggstöd kan detta användas. Var försiktig när du lägger över brukaren på andra sidan. Se till att hon/han inte tippas runt och rullar av sängen.

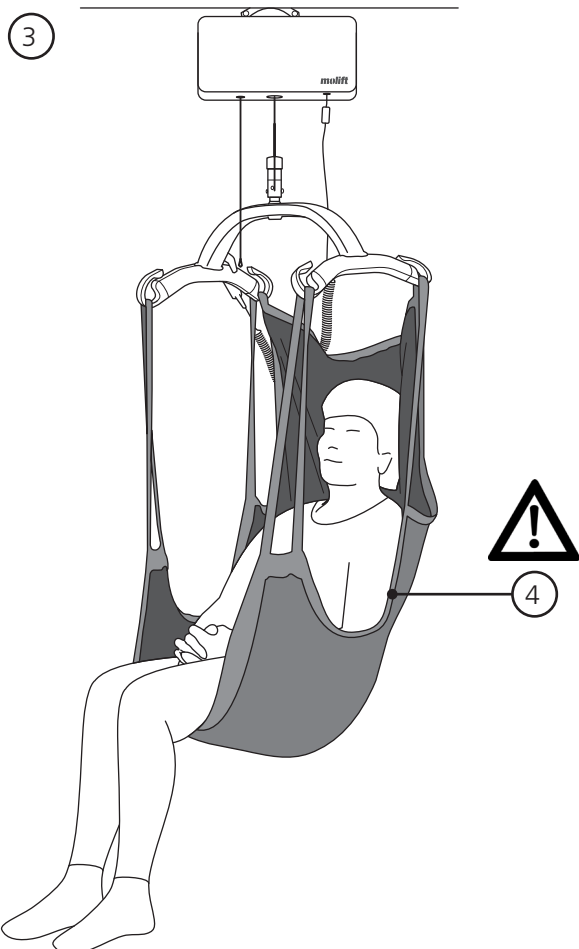

B3. Kors inte benstöden. Om brukaren saknar bålstabilitet eller är spastisk (ofrivilliga muskelsammandragningar) kan korsade benstöd innebära en risk för att brukaren ramlar ur selen. I detta fall rekommenderar vi så mycket liggläge som möjligt, med hjälp av de inre kopplingspunkterna på de nedre lyftremmarna.

B4. För att positionera brukaren till rätt sittande position finns det styrhandtag som används endast när brukaren är i lyft läge. Styrhandtaget ska inte användas som en bandögla för lyft.

Lyft

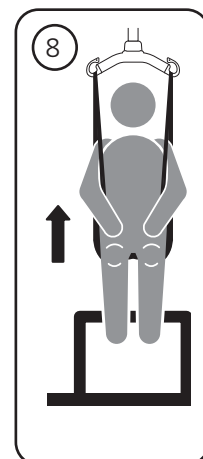
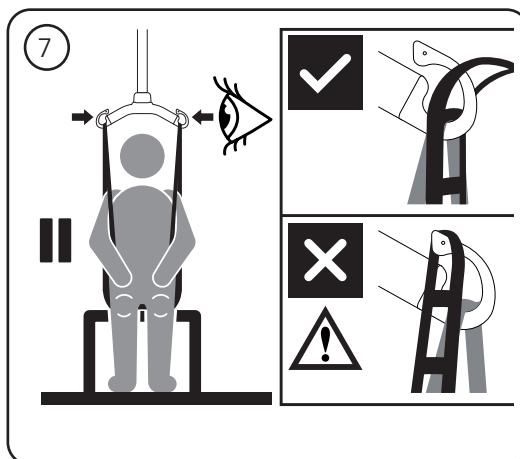
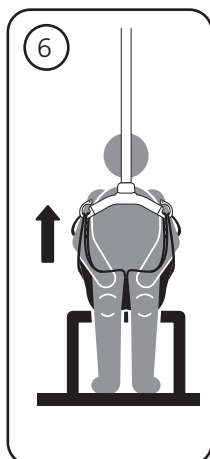
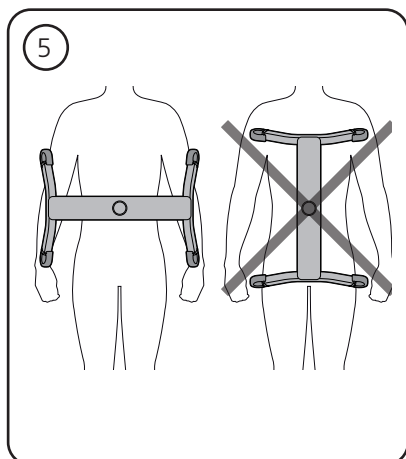

B5. Lyftbygeln skall alltid ställas på tvären över brukaren för att förhindra att brukaren oavsiktligt glider ur lyftselen.

B6. Häng upp selen i lyftbygels krokar.

B7. Sträck selens band utan att brukaren lyfts. Kontrollera att selen är rätt applicerad på

brukaren och att bandöglorna sitter rätt i bygelkrokarna.

B8. Lyft brukaren, dock inte högre än nödvändigt. Kom ihåg att hjulen INTE ska låsas på en mobil lyft.

Nedsänkning till sittande position

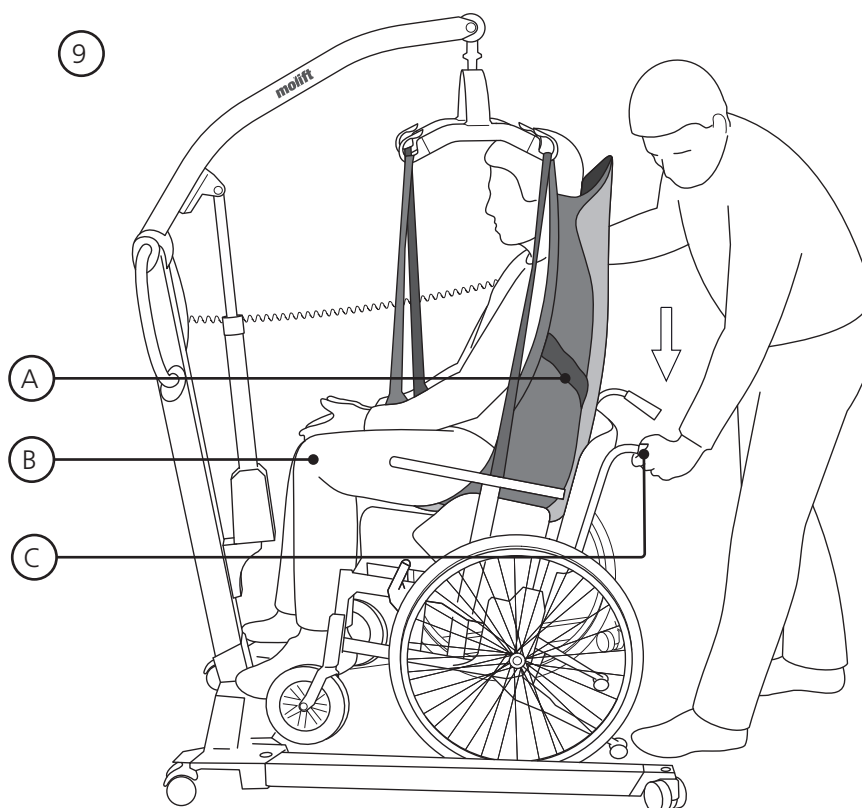

B9. När brukaren sänks ned till sittande position kan följande tekniker användas för att brukaren ska hamna så långt bak på sitsen som möjligt:

A. Placera brukaren med hjälp av styrhandtaget.
B. Tryck försiktigt på brukarens knän.
C. Luta sätet bakåt.

C

Justering av selen samt kontrollpunkter

RgoSling Comfort HighBack

- C1. Se till att brukaren inte har upphängningsanordningen nära ansiktet
- C2. Se till att huvudstödet inte är för lågt placerat. Selen ska vara placerad högre än brukarens huvud.
- C3. Kontrollera att selen sitter bra under låren.
- C4. Kors inte de nedre bandöglorna.

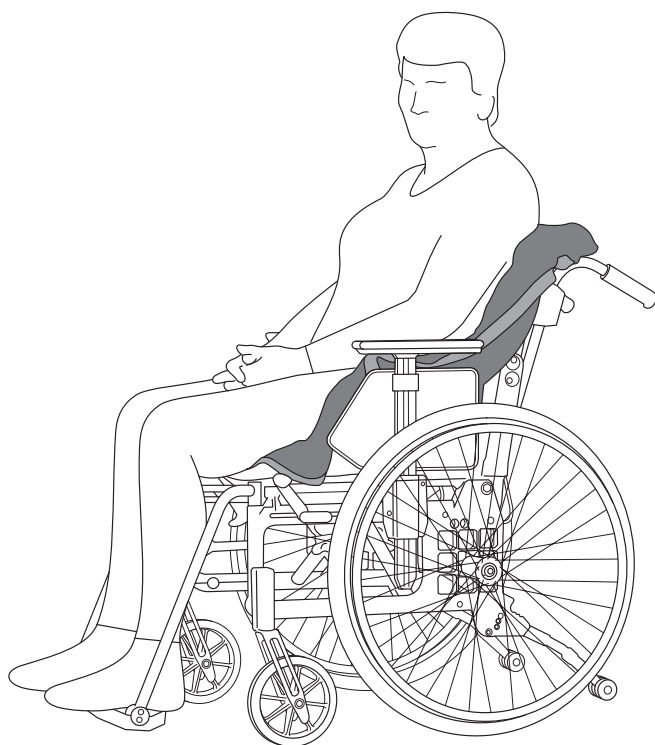
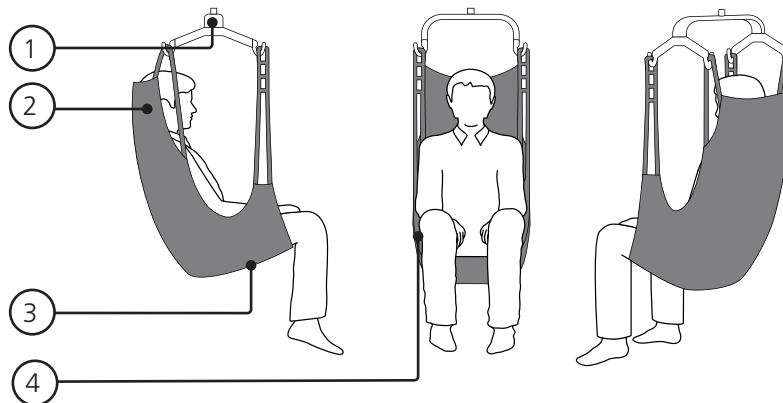

- C5. Selen ska sitta kvar under brukaren efter förflyttning.



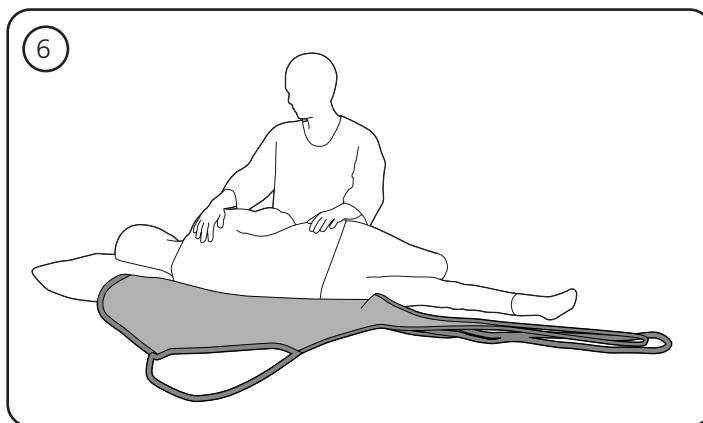



Ta av sele



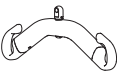
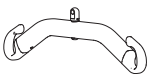
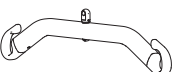

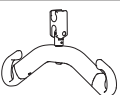
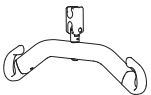
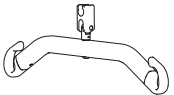

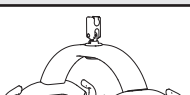
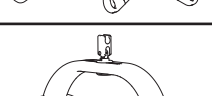
C6. Ta av öglorna från upphängningen. Vänd brukaren mot dig så att han/hon ligger på sidan i en säker position. Vik lyftselen på mitten och placera den bakom brukarens rygg. Vänd sedan brukaren över på motsatt sida

och dra undan lyftselen. Var försiktig när du lägger över brukaren på andra sidan. Se till att brukaren inte tippar runt och rullar av sängen.

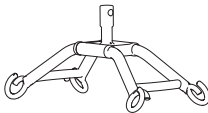
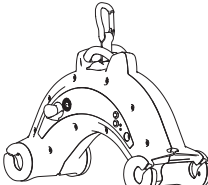
Kombinationslista

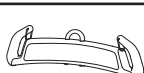
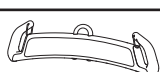
Bygel		RgoSling Comfort HighBack		
		S	M	L
Mover 180				
	2-pt Small	✓		
	2-pt Medium	✓	✓	
	2-pt Large		✓	✓
	4-pt Medium	✓	✓	✓
	4-pt Large		✓	✓
Mover 205				
	2-pt Small	✓		
	2-pt Medium	✓	✓	
	2-pt Large		✓	✓
	4-pt Medium	✓	✓	✓
	4-pt Large		✓	✓
Mover 300				
	4-pt Medium	✓	✓	✓
	4-pt Large		✓	✓
Partner 255				
	4-pt Medium	✓	✓	✓
	4-pt Large		✓	✓

Bygel		RgoSling Comfort HighBack		
Smart		S	M	L
	4-pt Medium	✓	✓	✓
Nomad				
	4-pt Medium	✓	✓	✓
Nova				
	2-pt Small	✓		
	2-pt Medium	✓	✓	
	2-pt Large		✓	✓
	4-pt Medium		✓	✓
	4-pt Large			✓

Selguide

Vilken storlek man ska välja beror dels på personens vikt, funktion, och på kroppsomfånget/storleken.

SWL (Safe Working Load) är 300 kg.

Felsökning

Symptom	Möjlig orsak/åtgärd
Selen passar inte brukaren.	Fel storlek på selen. Prova med en annan storlek.
	Lyftselen är för liten när benstöden inte når runt minst halva lårens insida och upphängningen kommer för nära ansiktet. Prova med en annan storlek.
	Lyftselen är inte korrekt placerad. Dra ned selen tillräckligt långt i ryggen vid applicering.
Alla band lyfter inte samtidigt.	Lyfter lyftselens band ojämnt innebär det att lyftselen kan glida upp i ryggen vilket får till följd att brukaren glider ner i lyftselens hål. Se till att benstöden är rätt placerade på låren.

EN

SV

NO

DA

FI

DE

NL

FR

IT

ES

Norsk manual

Innhold

Generelt.....	24
Test og Garanti.....	24
Sikkerhetsforskrifter.....	25
Inspeksjon	25
Periodisk inspeksjon	25
Beskrivelse	26
Etac Molift RgoSling Comfort HighBack.....	26
Vaskeanvisninger	26
Seil applisering liggende	28
Løfting.....	29
Senke brukeren til sittende stilling	29
Seil justering og kontrollpunkter.....	30
Fjerning av seil.....	31
Kombinasjonsliste	32
Seilguide	32
Feilsøking.....	33

Test og Garanti

 Dette produktet er CE merket

Etac Molift seil er testet av akkrediterte test institutt og tilfredsstillende standarder I Medical Devices Directive for Class 1 Products MDR (EU) 2017/745. Seilene oppfyller kravene spesifisert i EN ISO 10535 standarden.

Garanti: 2 år for material og produksjonsfeil ved korrekt bruk.

Besøk www.molift.com for flere detaljer om Etac Molift sitt seil og løfter sortiment

Generelt

Takk for at du valgte et seil fra Molift by Etac.

Brukermanualen må leses grundig for å unngå skade ved håndtering og bruk av produktet

I denne brukermanualen er "bruker" personen som løftes. "Assistenten" er personen som opererer løfteren.



Dette symbolet brukes i manualen der teksten tilsier at det er nødvendig med varsomhet med tanke på brukeren eller assistentens sikkerhet.

Etac forbedrer kontinuerlig produktene, derfor reserverer vi oss retten til å modifisere produktene uten forvarsel.



Besøk www.molift.com for mer informasjon, tips og råd og oppdaterte dokumenter

Vi kan ikke holdes ansvarlig for trykkfeil eller utelatelser

Sikkerhetsforskrifter



Manualen for både løfter og seil må leses nøye før bruk for å unngå skade ved håndtering og bruk av produktet

måned. Hvis seilet vaskes mer enn normalt kan det være nødvendig hyppigere inspeksjoner. See periodisk inspeksjon skjema på www.molift.com

Det er viktig at seilet har blitt testet individuelt med bruker og for den tiltenkte forflytningssituasjonen. Gjør en vurdering om det er nødvendig med en eller flere assistenter.

Planlegg løfteoperasjonen på forhånd for å forsikre at den kan gjennomføres så behagelig og sikkert som mulig. Husk å arbeide ergonomisk.

Vurder risikoen og ta notater. Assistenten er ansvarlig for sikkerheten til brukeren.



Aldri løft brukeren høyere enn nødvendig for å gjennomføre overflytningen. Aldri la brukeren være uten tilsyn i en løftesituasjon



Alltid kontroller:

- At brukeren har nødvendig funksjonsevne for det valgte seilet.
- Modell, størrelse og material passer.
- Seilet passer for løfteren/opphenget som skal brukes.
- Det er viktig å sjekke at løkker er korrekt festet til krok på opphenget før brukeren løftes.
- Hjulene på rullestol eller seng må være låst når det er nødvendig ved overflytning.

Inspeksjon

Seilet må inspiseres regelmessig, helst før hver gang det brukes, men spesielt etter vask.

- Sjekk at det ikke er noen slitasje eller skader på sømmer, stoff, stropper løkker.



Aldri bruk skadede eller slitte seil fordi seilet kan ryke og det kan føre til personskade. Destruer og kast alle skadede og gamle seil.



Seilet må ikke oppbevares i direkte sollys.

Periodisk inspeksjon

Periodisk Inspeksjon må utføres minst hver 6.

Beskrivelse

Etac Molift tilbyr et bredt sortiment med seil for forskjellige typer forflytninger. Etac Molift RgoSling er designet for å gi jevn belastning og en så komfortabelt som mulig forflytning.

Seilets øvre løftestropp er glidende og gjør det mulig å finne jevn balanse gjennom hele forflytningen. Dette gir brukeren høy komfort og en behagelig forflytning. Seilet har applisseringslommer på rygg og benstøtter for å forenkle applisering på bruker.

Seilet har styrehåndtak for å gjøre det enklere å hjelpe brukeren over i riktig stilling og skal kun brukes når brukeren er løftet.

Etac Molift RgoSling er utviklet for bruk med 4-punkts oppheng, men seilet fungerer også med 2-punkts oppheng. Se kombinasjonslisten for riktig kombinasjonsmuligheter for seil og oppheng.

Molift RgoSling Comfort Highback finnes i størrelse S-L i polyester netting.

Molift RgoSling Comfort HighBack

Er et upolstret seil som former seg til kroppen. Seilet er tiltenkt å forbli under bruker etter gjennomført forflytning. Seilet er lagd av polyester netting som slipper gjennom kroppsvarme og fuktighet. Seilet kan kun appliseres med bruker i liggende stilling. Armene skal plasseres på innsiden av seilet, og det gir en komfortabel sittende stilling med full støtte for hode og kropp.

Produktet har en forventet levetid på 1 til 5 år ved normal bruk. Forventet levetid varierer avhengig av bruksmengde, materialer, hvor stor last og hvor ofte seilet vaskes.

A1. Produktmerkelapp

A2. (01) EAN-kode

xxxxxxxxxxxxxxxx

(21) Serialnummer

xxxxxxx

A3. QR-kode

A4. Merkelapp: Periodisk inspeksjon

A5. Merkelapp: Brukernavn

A6. Øvre løftestropp

A7. Styrehåndtak side

A8. Nedre løftestropp

A9. Symbol: Les brukermanual

A10. Symbol: Maks brukervekt

A11. Symbol: Denne side av produktet er vendt opp og utover

A12. Symbol: Brett ut for mer informasjon

Vaskeanvisninger

Les vaskeanvisninger på produktet.

1. Seil som kan vaskes i vann kan vaskes på temperatur fra 60 til 85° C.



Vask på høyere temperaturer gjør at stoffet slites ut raskere.

2. Tørketrommel, maks 45° C.

Kan autoklaves på 85° C i 30 minutter

3. Skal ikke renses kjemisk.

4. Skal ikke blekes.

5. Skal ikke strykes.

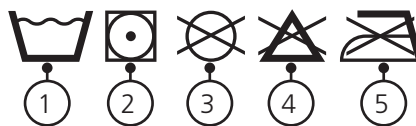

Symboler:



Produsent



Produksjonsdato.
ÅÅÅÅ-MM-DD
(år/måned/DD)



CE-merket



Se bruksanvisningen



Denne siden opp,
denne siden ut



max 255 kg max 560 lbs Maks. brukervekt (SWL)



Medisinsk utstyr

A

RgoSling Comfort HighBack

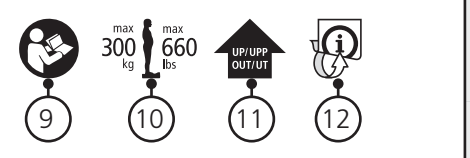
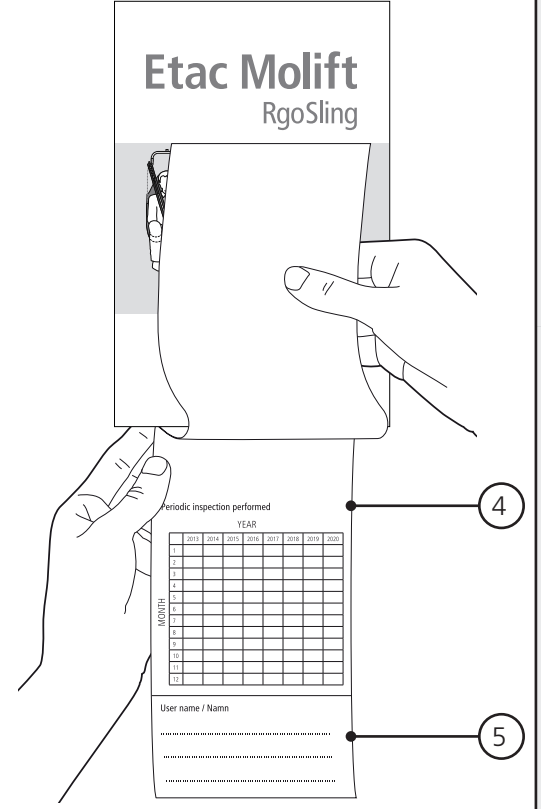
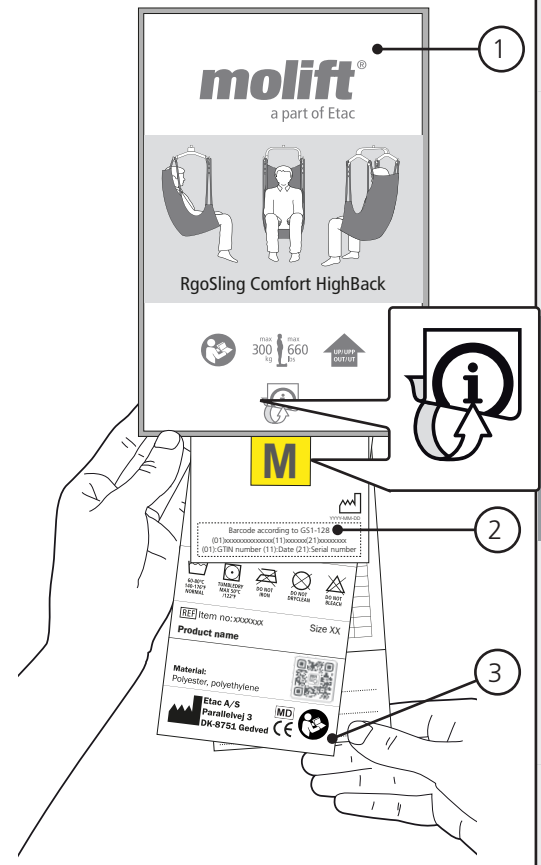
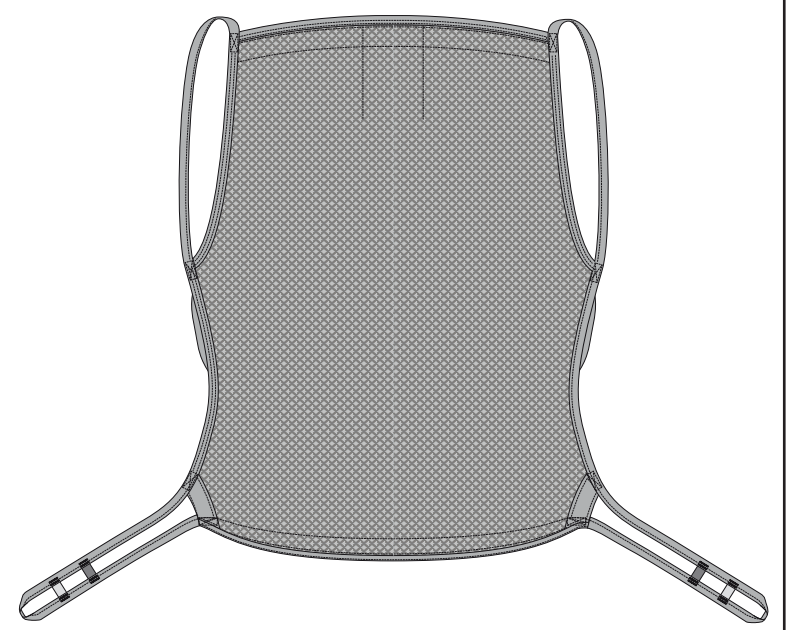
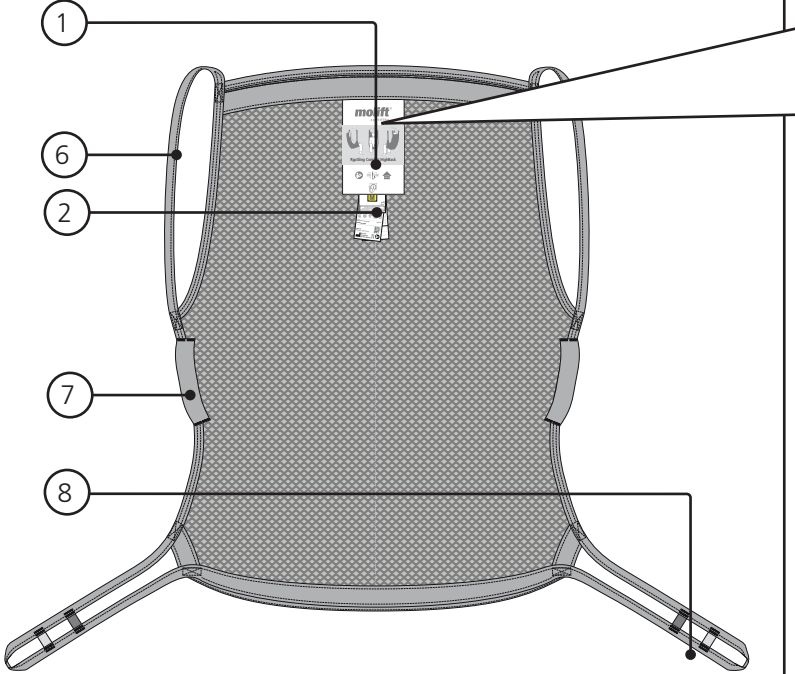

B

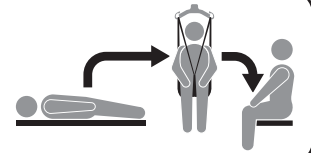

Seil applisering liggende

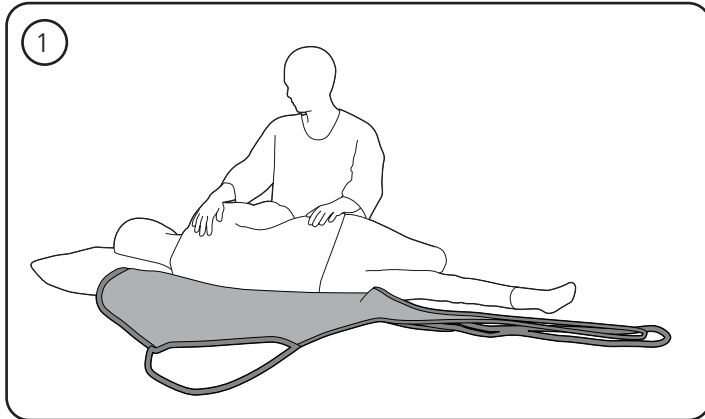

B1. Vend brukeren mot deg til han/hun ligger i stabilt sideleie. Brett seilet på midten og plasser det bak brukerens rygg.

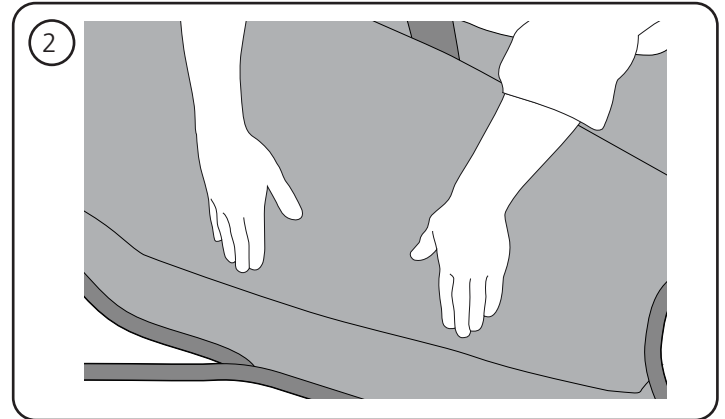

B2. Vend så brukeren over på motsatt side og trekk frem seilet. Pass på at brukeren er plassert i senter på seilet. Hvis sengen har bakstøtte kan den brukes. Vær forsiktig når brukeren vendes over til andre siden. Pass på at brukeren ikke ruller ut av sengen.

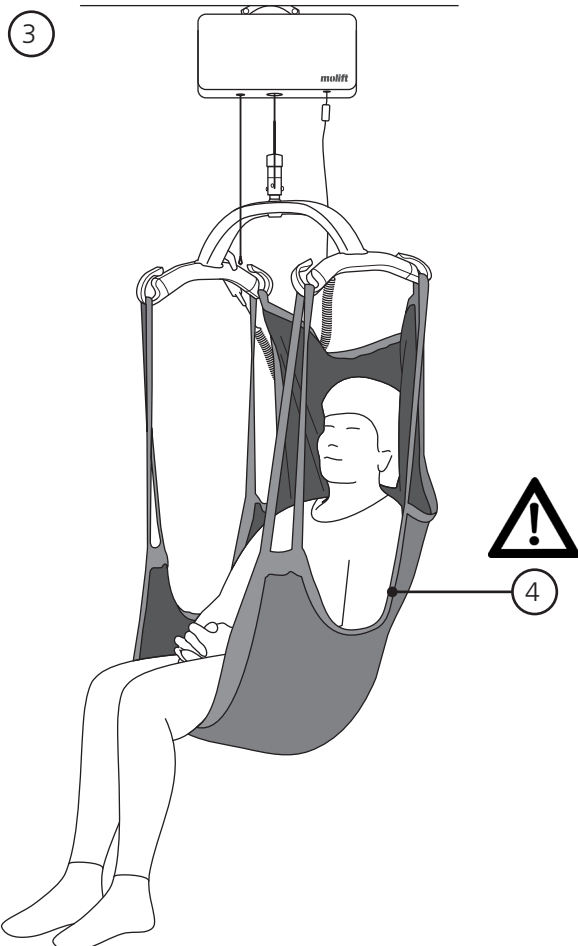

B3. Ikke kryss benstøttene. Hvis brukeren har ustabilitet i overkroppen, eller er spastisk (har ufrivillige muskelsammentrekninger) så er det en fare for at brukeren faller hodestups ut av seilet. I slike tilfeller anbefales en så tilbakelent stilling som mulig, ved å bruke innerste låseløkke på nedre løftestropp.

B4. Det finnes et styrehåndtak for å hjelpe bruker over i rett sittestilling og kan brukes kun når brukeren er i løftet stilling. Styrehåndtaket er ikke en løftestropp!

Løfting

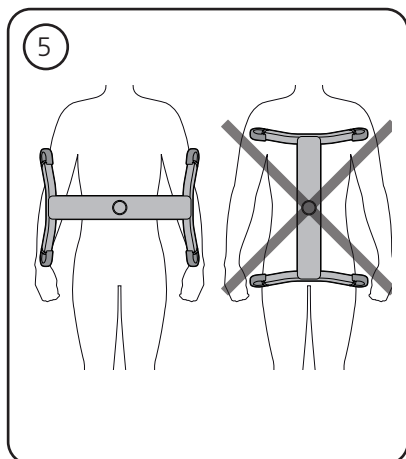

B5. Opphenget må alltid plasseres på tvers av bruker for å unngå at brukeren faller ut av seilet.

B6. Koble løkkene til opphengets kroker.

B7. Løft til stroppene strammes uten at bruker løftes. Sjekk at seilet er riktig applisert på

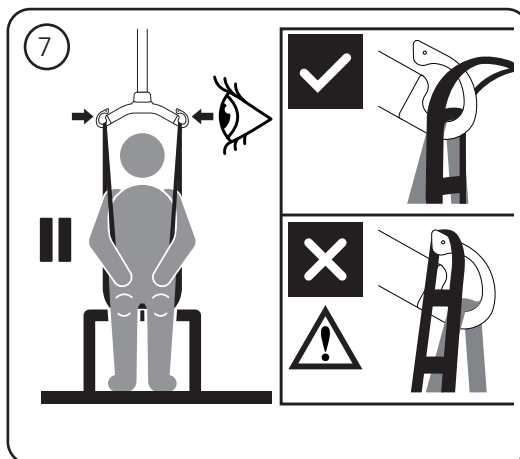
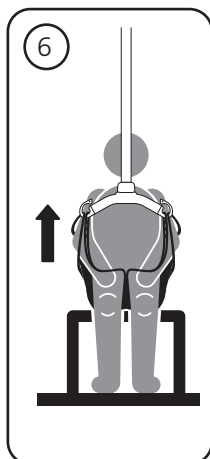

bruker og at løkkene er skikkelig festet til opphengets kroker..

B8. Løft ikke brukeren høyere en nødvendig. Huska at hjul på mobile løfter IKKE skal være låst

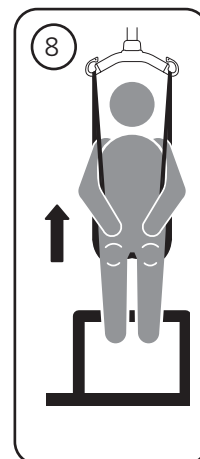

Senke brukeren til sittende stilling

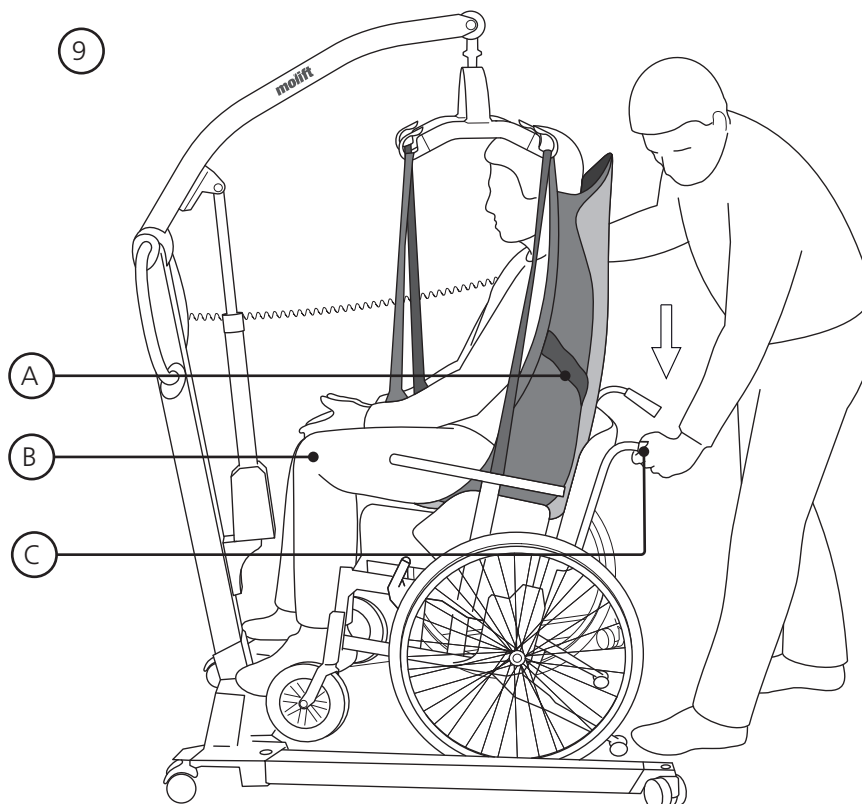

B9. Når brukeren forlyttes til sittende kan følgende teknikker brukes for å senke brukeren så langt bak i setet som mulig:

A. Styr brukeren med styrehåndtakene på seilet
B. Skyv forsiktig på brukers knær
C. Tipp setet bakover

C

Seil justering og kontrollpunkter

RgoSling Comfort HighBack

- C1. Sørg for at opphenget ikke er i nærheten av brukerens ansikt.
- C2. Sørg for at hodestøtte ikke er for lav, seilet skal plasseres høyere enn brukerens hode.
- C3. Sørg for at seil er godt plassert under brukerens lår.
- C4. Ikke kryss benstøtter

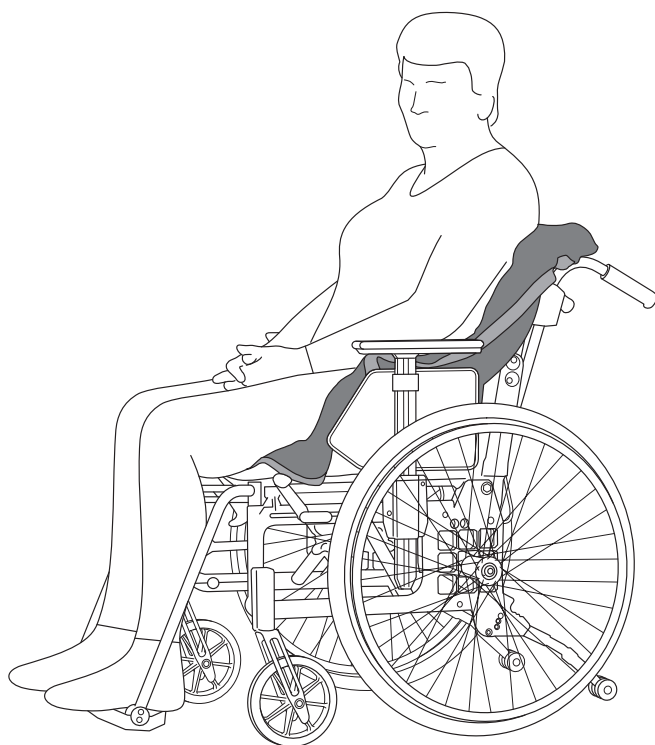
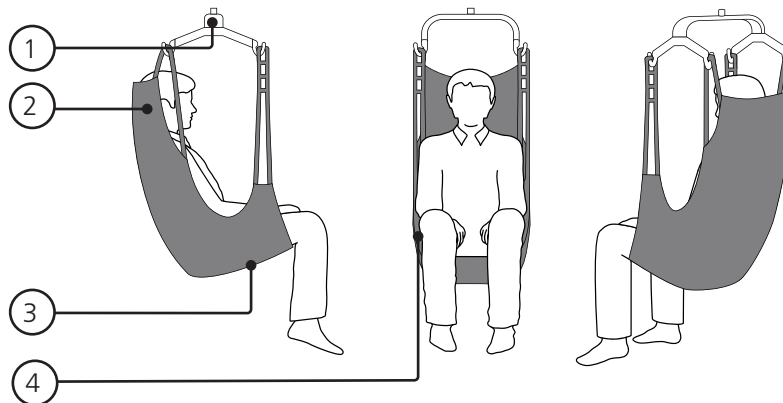





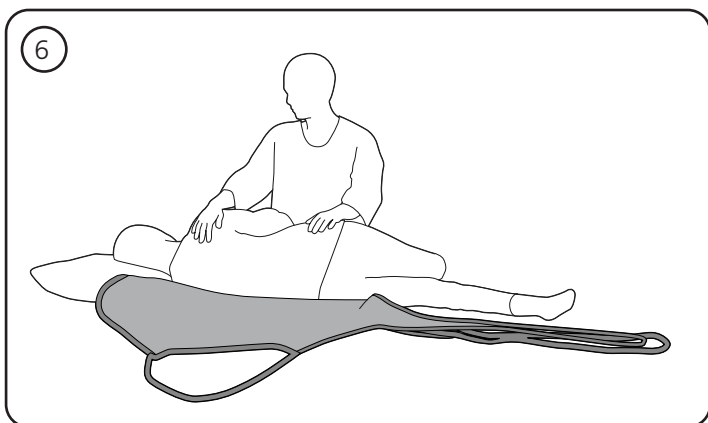



- C5. Seilet er tiltenkt å forbli under bruker etter forflytning.

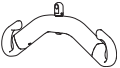
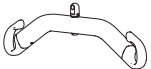
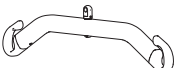

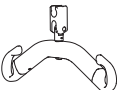
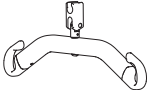
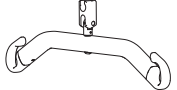

Fjerning av seil

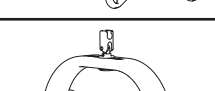

C6. Løs stroppene fra opphenget. Vend brukeren mot deg til han/hun ligger i stabilt sideleie. Brett seilet på midten og vend brukeren over på motsatt side og trekk bort seilet. Vær forsiktig når brukeren vendes over til andre siden. Pass på at brukeren ikke ruller ut av sengen.

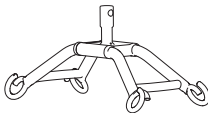
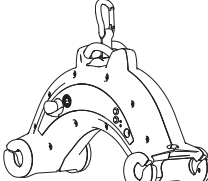
Kombinasjonsliste

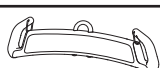
Oppheng		RgoSling Comfort HighBack		
		S	M	L
Mover 180				
	2-pt Small	✓		
	2-pt Medium	✓	✓	
	2-pt Large		✓	✓
	4-pt Medium	✓	✓	✓
	4-pt Large		✓	✓
Mover 205				
	2-pt Small	✓		
	2-pt Medium	✓	✓	
	2-pt Large		✓	✓
	4-pt Medium	✓	✓	✓
	4-pt Large		✓	✓
Mover 300				
	4-pt Medium	✓	✓	✓
	4-pt Large		✓	✓
Partner 255				
	4-pt Medium	✓	✓	✓
	4-pt Large		✓	✓

Oppheng		RgoSling Comfort HighBack		
Smart		S	M	L
	4-pt Medium	✓	✓	✓
Nomad				
	4-pt Medium	✓	✓	✓
Nova				
	2-pt Small	✓		
	2-pt Medium	✓	✓	
	2-pt Large		✓	✓
	4-pt Medium		✓	✓
	4-pt Large			✓

Seilguide

Valg av størrelse varierer avhengig av vekt, kroppsfunksjon og omkrets/størrelse på brukeren. SWL (Maks last) er 300.

Feilsøking

Symptom	Possible Cause/Action
Seilet passer ikke brukeren	Feil størrelse på seilet. Prøv en annen størrelse.
	Seilet er for lite når benstøttene ikke rekker halvveis rundt låret og opphenget er for nærme brukerens ansikt. Prøv en annen størrelse.
	Seilet er ikke plassert riktig. Sørg for å skyve seilet langt nok ned bak ryggen når det appliseres.
Stroppene løfter ikke samtidig	Hvis løftestroppene løfter ujevnt så kan det føre til at seilet gli opp langs ryggen og brukeren kan gli ut gjennom åpningen av seilet. Sørg for at benstøttene er plassert korrekt.

EN

SV

NO

DA

FI

DE

NL

FR

IT

ES

Dansk vejledning

Indhold

Generelt.....	34
Test og garanti	34
Sikkerhedsforanstaltninger.....	35
Inspektion	35
Periodisk inspektion	35
Beskrivelse	36
Etac Molift RgoSling Comfort HighBack.....	36
Pleje/vask	36
Sejlanvendelse, liggende	38
Løftning.....	39
Nedsænkning til siddende stilling	39
Sejljustering og kontrolpunkter	40
Fjernelse af sejl	41
Kombinationsoversigt	42
Valg af sejl	42
Fejlfinding	43

CE Dette produkt er CE-mærket.

Etac Molift-sejl er testet af godkendte testinstitutioner og overholder de standarder, der er angivet i Direktivet for medicinsk udstyr for klasse 1-produkter MDR (EU) 2017/745. Sejlene opfylder de krav, der er angivet i standarden EN ISO 10535.

Garanti: To år på materiale- og fremstillingsfejl, under forudsætning af korrekt brug.

Se www.molift.com for yderligere oplysninger om Etac Molifts udvalg af sejl og personløftere.

Generelt

Tak, fordi du har valgt et Molift-sejl fra Etac

Læs vejledningen grundigt for at undgå skader under håndtering og brug af produktet.

I vejledningen er Brugeren den person, der bliver løftet. Hjælperen er den person, der betjener sejlet.



Dette symbol vises i vejledningen sammen med tekst. Det angiver behov for forsigtighed, når der kan være risiko for brugerens eller hjælperens sikkerhed.

Etac forbedrer løbende sine produkter. Vi forbeholder os derfor ret til at ændre produkterne uden forudgående meddelelse.



Besøg www.molift.com for at få flere oplysninger, tips og eventuelle dokumentationsopdateringer.

Vi frasiger os ansvaret for eventuelle trykfejl eller udeladelser.

Test og garanti

Sikkerhedsforanstaltninger



Læs vejledningen til både personløfter og sejl grundigt før brug for at undgå skader under håndtering og brug af produktet.

Der skal som minimum udføres periodisk inspektion hver sjette måned. Det kan være nødvendigt med hyppigere inspektion, hvis sejlet anvendes eller vaskes oftere end det normale. Se formular for periodisk inspektion på www.molift.com.

Det er vigtigt, at sejlet er blevet afprøvet sammen med den enkelte bruger og anvendes til den tilsigtede løftesituation. Der skal tages beslutning om, hvorvidt det er nødvendigt med kun en eller flere hjælpere.

Planlæg løfteoperationen på forhånd for at sikre, at den foregår så sikkert og ubesværet som muligt. Husk at arbejde ergonomisk korrekt.

Vurdér risiciene, og tag notater. Som omsorgsperson er du ansvarlig for brugerens sikkerhed.



Løft aldrig en bruger højere fra udgangspunktet, end det, der er nødvendigt for at kunne udføre løftet. Efterlad aldrig en bruger uden opsyn i en løftesituation.



Kontrollér altid:

- om brugeren har de nødvendige evner i forhold til det aktuelle sejl.
- At model, størrelse og materiale er hensigtsmæssige.
- At sejlet egner sig til det løft, der skal udføres.
- Det er vigtigt at kontrollere, at stropløkkerne er korrekt fastgjort i løftekrogene, før brugeren løftes.
- Sørg for, at hjulene på kørestolen, sengen eller lejet er låst, når det er nødvendigt i forbindelse med forflytningsprocessen.

Inspektion

Sejlet skal inspiceres regelmæssigt, helst før hver enkelt løfteoperation, men specielt efter det er blevet vasket.

- Kontrollér sejlet for at sikre dig, at der ikke er slitage eller skader på sømme, stof, stropper og løkker.



Anvend aldrig et fejlbehæftet eller beskadiget sejl, da det kan gå i stykker og forårsage personskade. Kassér og bortskaf beskadigede og gamle sejle.



Sejlet må ikke opbevares i direkte sollys.

Periodisk inspektion

Beskrivelse

Etac Molift leverer et bredt udvalg af sejle til forskellige forflytningstyper. Etac Molift RgoSling er konstrueret til at fordele vægt og belastning jævnt, så sejlet er så komfortabelt som muligt.

Sejlets øverste ophængsstropper er forskydelige, så sejlet kan bringes i ligevægt under hele forflytningen. På denne måde opnår brugeren stor komfort og en behagelig løftning. Sejlene har påsætningslommer på bagsiden og på benstøtterne for at lette påsætningen.

Sejlet har et styregreb, som gør det nemmere at placere brugeren i den korrekte siddestilling. Grebet anvendes kun under løft.

Etac Molift RgoSling er konstrueret til at blive kombineret med et 4-punkts løfteophæng, men sejlet kan også benyttes med et 2-punkts løfteophæng. For korrekt kombination af sejl og løfteophæng, se kombinationsoversigten.

Molift RgoSling Comfort Highback findes i størrelserne S-L, i polyesternet..

Molift RgoSling Comfort HighBack

Molift RgoSling Comfort HighBack er et upolstret sejl, som tilpasser sig efter kroppen. Sejlet skal forblive under brugeren, efter at løftet og forflytningen er gennemført. Det er fremstillet af et polyesternetmateriale, der gør det muligt for kropsfugt og -varme at trænge igennem. Sejlet kan kun påsættes med brugeren i liggende stilling. Armene anbringes indvendigt i sejlet, og sejlet sikrer en komfortabel siddestilling med fuld støtte af hoved og krop.

Produktet har en forventet levetid på 1-5 år ved normal brug. Levetiden for produktet varierer, afhængigt af brugshyppighed, materialer, belastninger og hvor ofte, det vaskes.

- A1. Produktmærkat
- A2. (01) EAN-kode
xxxxxxxxxxxxxxx
(21) Serienummer
xxxxxxx
- A3. QR-kode
- A4. Mærkat: Periodisk inspektion
- A5. Mærkat: Brugernavn
- A6. Øverste stropløkker
- A7. Styregreb, side
- A8. Nederste stropløkker
- A9. Symbol: Læs vejledningen inden brug.
- A10. Symbol: Maks. brugervægt
- A11. Symbol: Denne side af produktet vendes opad og udad
- A12. Symbol: Fold ud for flere oplysninger

Pleje/vask

Læs instruktionerne for pleje/vask på produktet.

1. Vaskbare sejl kan vaskes i vand ved temperaturer mellem 60 og 85 °C.
2. Vask ved højere temperaturer vil bevirke, at materialet slides hurtigere.
3. Kan tørretumbles ved maks. 45 °C. Kan autoklaveres ved 85 °C i 30 minutter.
4. Ingen kemisk rens.
5. Ingen blegning.
6. Ingen strygning.

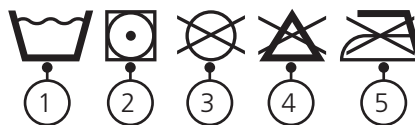

Symboler:



Producent



Denne side op, denne side er ydersiden



Produktionsdato.
ÅÅÅÅ-MM-DD
(år/måned/dag)



Maks. brugervægt
(sikker arbejdsbelastning)



CE-mærket



Medicinsk udstyr



Se brugervejledning

A

RgoSling Comfort HighBack

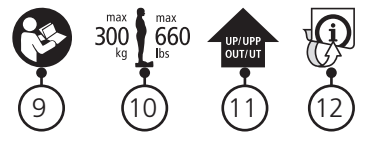
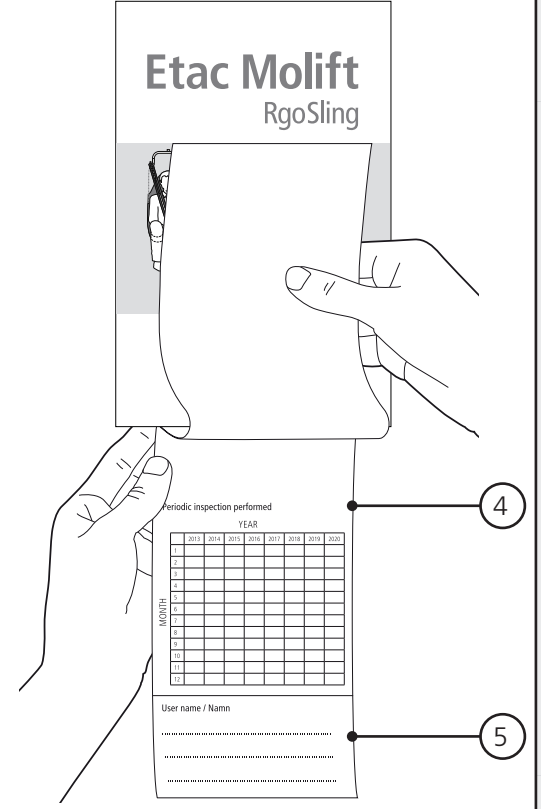
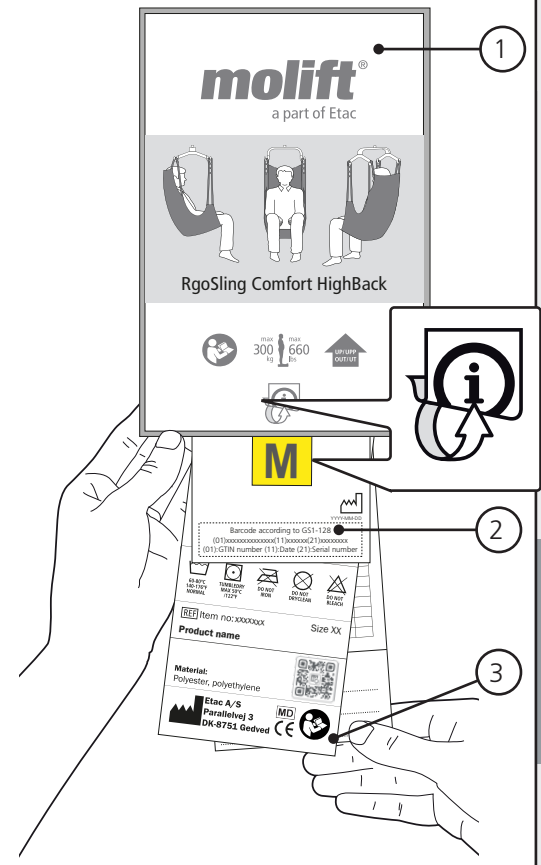
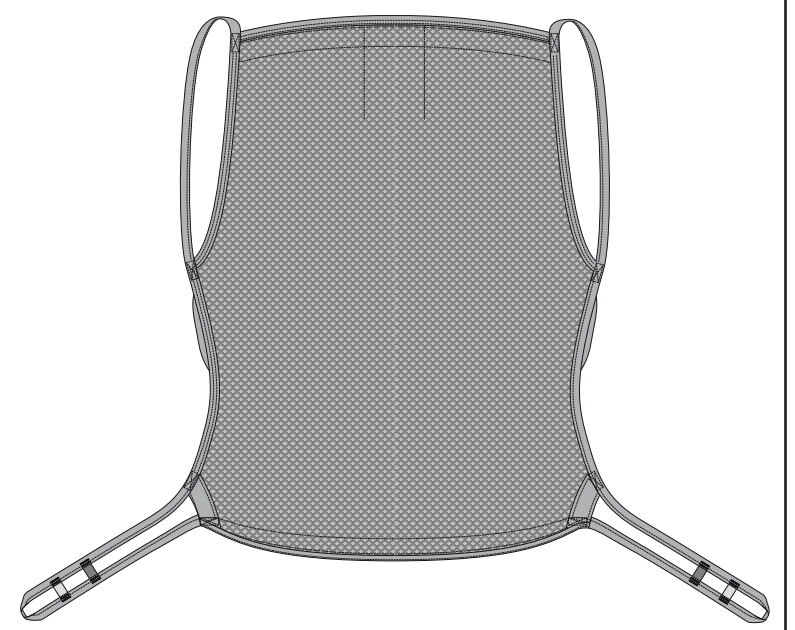
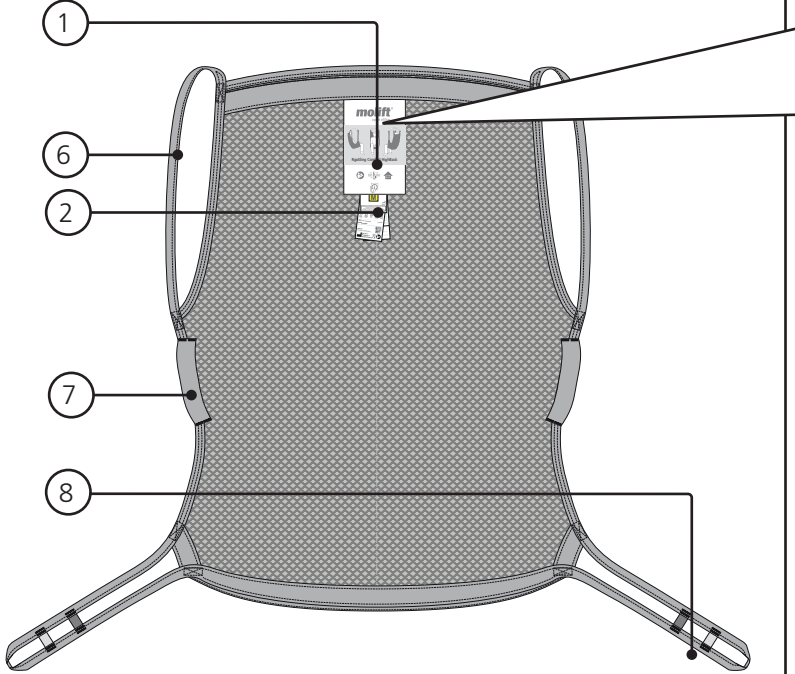

B

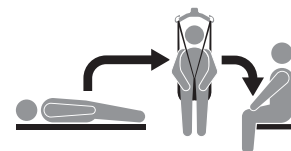

Sejlanvendelse, liggende

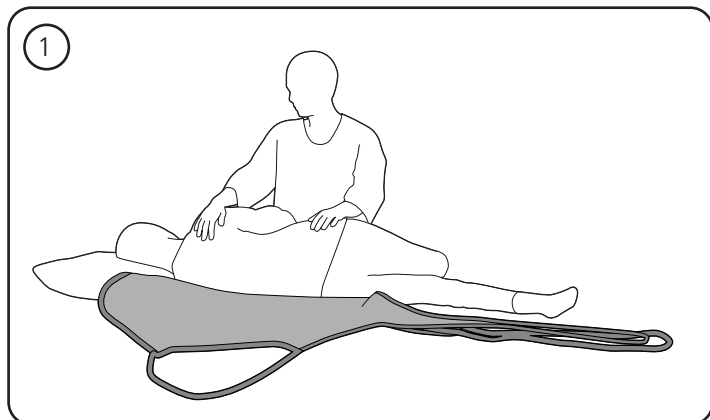

B1. Vend brugeren mod dig, indtil vedkommende ligger sikkert på siden. Fold sejlet midtpå, og anbring det bag brugerens ryg.

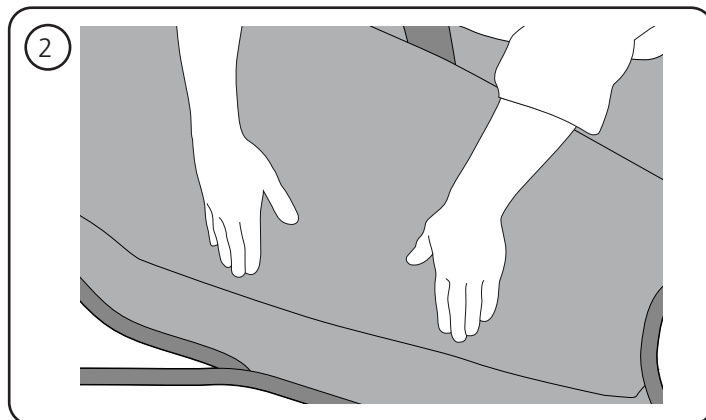

B2. Vend derefter brugeren om på den modsatte side, og træk sejlet fremad. Sørg for, at brugeren befinder sig midt på sejlet. Hvis sengen har en rygstøtte, kan den anvendes. Vær forsigtig, når du vender brugeren om på den anden side. Sørg for, at vedkommende ikke vender rundt og ruller ud af sengen.

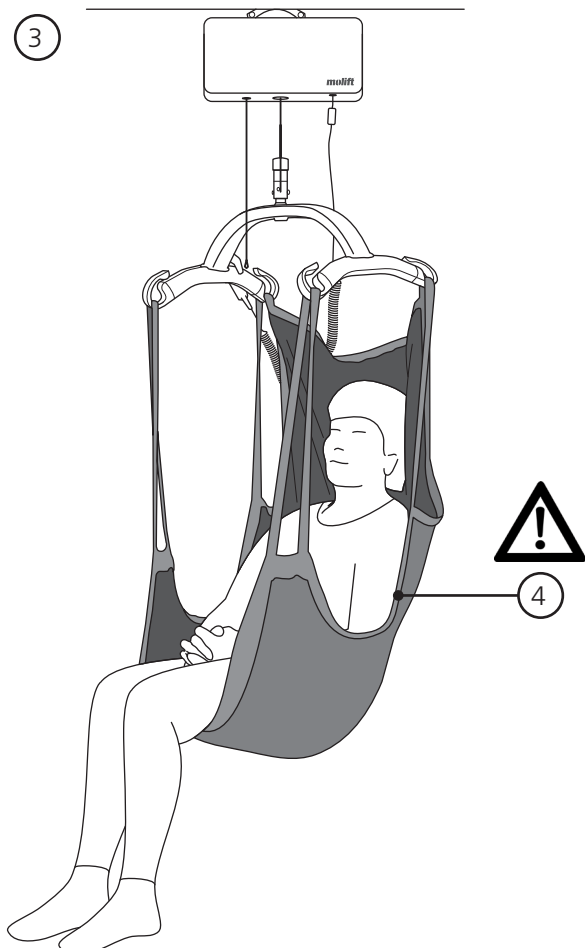

B3. Kryds ikke benstøtten. Hvis brugeren har en ustabil torso eller spastisk lammelse (ufrivillige muskelsammentrækninger), kan det bevirke, at vedkommende falder på hovedet ud af sejlet. Vi anbefaler i stedet, at brugeren læner sig så meget tilbage som muligt, og at du anvender de indvendige fastgørelsespunkter på de nederste løftestropper.

B4. Sejlet har et styregreb, som gør det nemmere at placere brugeren i den korrekte siddestilling. Grebet anvendes kun under løft. Det er ikke en stropløkke, der kan anvendes til løft.

Løftning

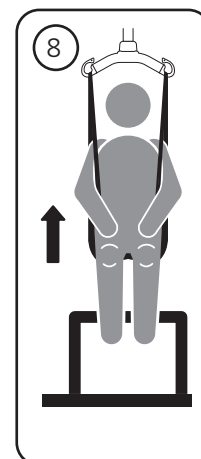
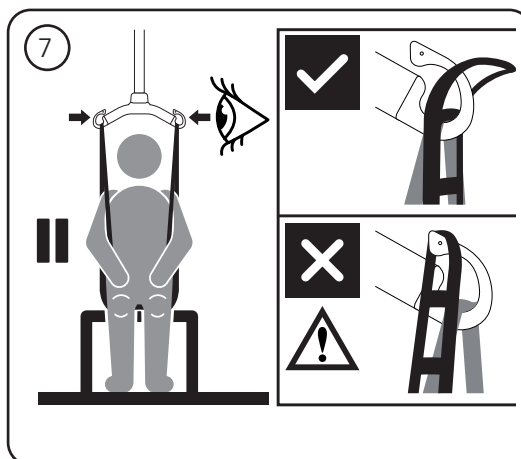
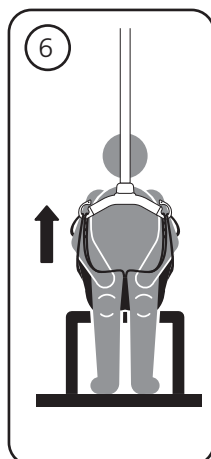
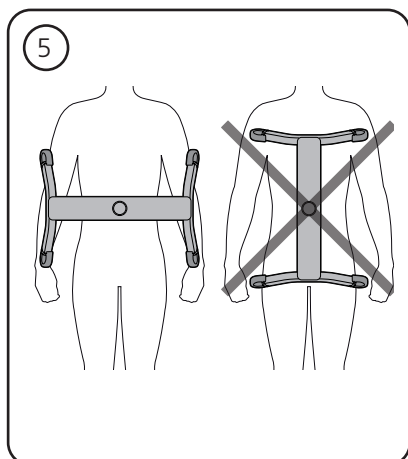

B5. Løfteophænget skal altid anbringes på tværs af brugeren for at forhindre, at brugeren ved et uheld glider ud af sejlet.

B6. Hæng sejlet i krogene på løfteophænget.

B7. Stræk sejlstropperne uden at løfte brugeren. Sørg for, at sejlet er placeret korrekt omkring

brugeren, og at stropløkkerne er placeret korrekt i krogene på løfteophænget.

B8. Løft ikke brugeren højere op end nødvendigt. Husk, at hjulene på en mobil personløfter IKKE må låses.

Nedsænkning til siddende stilling

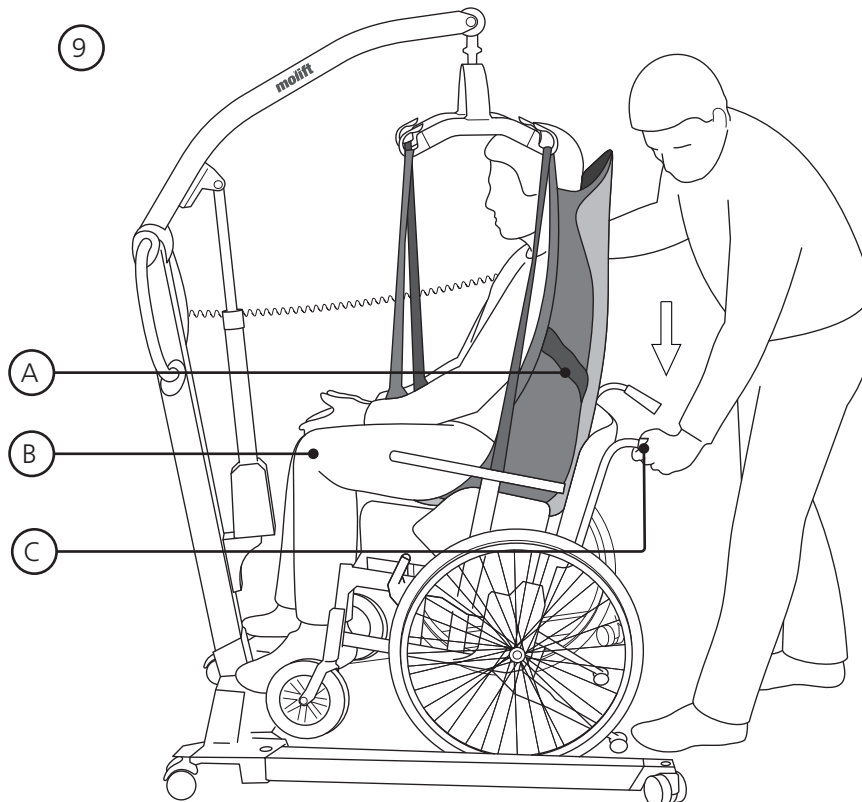

B9. Når brugeren overføres til siddende stilling kan følgende teknikker anvendes, når brugeren skal sænkes så langt tilbage i sædet som muligt:

A. Placér brugeren ved hjælp af styregrebet
B. Skub forsigtigt på brugerens knæ
C. Tip sædet tilbage

C

Sejljustering og kontrolpunkter

RgoSling Comfort High-

- C1. Sørg for, at ophænget er på sikker afstand af brugerens ansigt
- C2. Sørg for, at hovedstøtten ikke er placeret for lavt; sejlet skal placeres højere end brugerens hoved.
- C3. Sørg for, at sejlet er placeret korrekt under lårene.
- C4. Kryds ikke de nederste stropløkker.

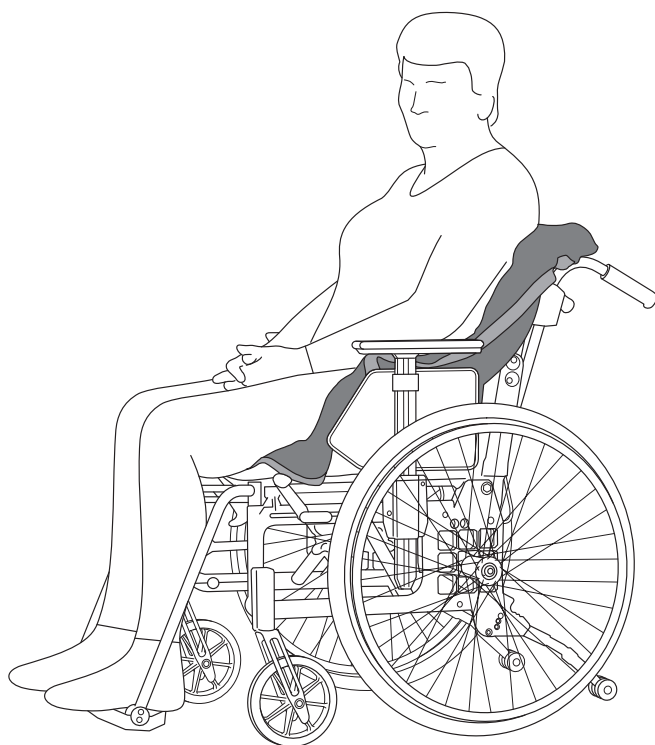
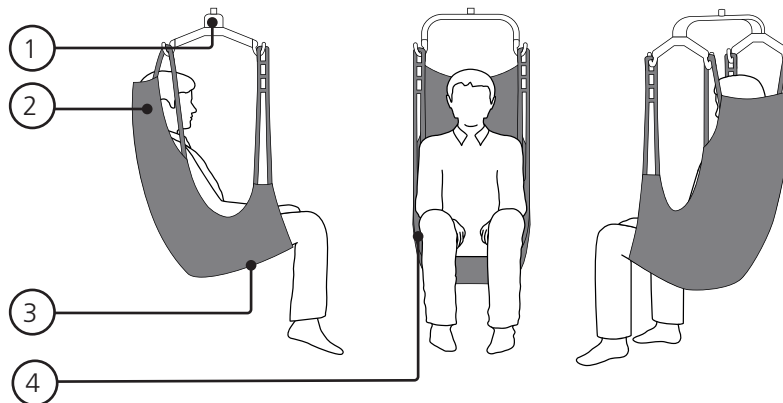

- C5. Sejlet er beregnet til at blive liggende under brugeren efter forflytning.



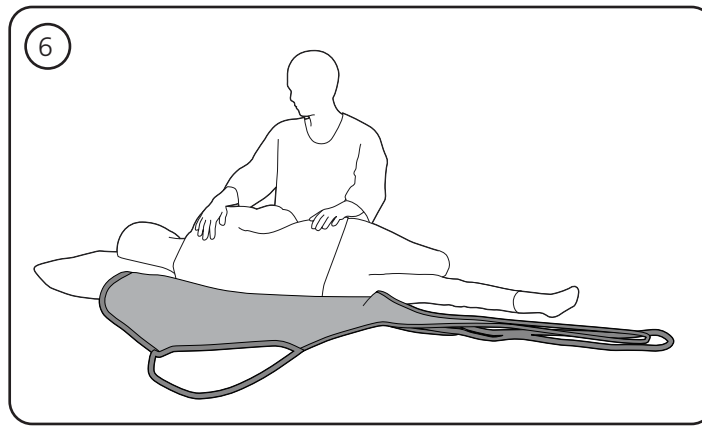





Fjernelse af sejl

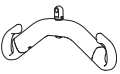
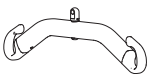
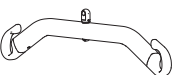

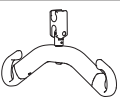
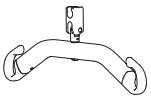
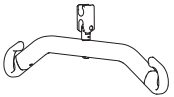

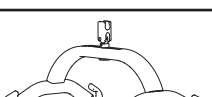

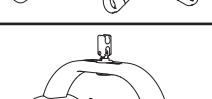

C6. Frigør løkkerne fra ophænget. Vend brugeren mod dig, indtil vedkommende ligger sikkert på siden. Fold sejlet midtpå, og anbring det bag brugerens ryg. Vend derefter brugeren over på

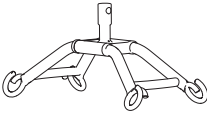
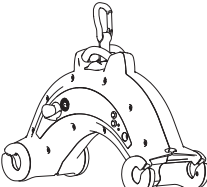
den modsatte side, og træk sejlet væk. Vær forsigtig, når du vender brugeren om på den anden side. Sørg for, at vedkommende ikke vender rundt og ruller ud af sengen.

Kombinationsoversigt

Suspension		RgoSling Comfort HighBack		
		S	M	L
Mover 180				
	2-pt Small	✓		
	2-pt Medium	✓	✓	
	2-pt Large		✓	✓
	4-pt Medium	✓	✓	✓
	4-pt Large		✓	✓
Mover 205				
	2-pt Small	✓		
	2-pt Medium	✓	✓	
	2-pt Large		✓	✓
	4-pt Medium	✓	✓	✓
	4-pt Large		✓	✓
Mover 300				
	4-pt Medium	✓	✓	✓
	4-pt Large		✓	✓
Partner 255				
	4-pt Medium	✓	✓	✓
	4-pt Large		✓	✓

Suspension		RgoSling Comfort HighBack		
Smart		S	M	L
	4-pt Medium	✓	✓	✓
Nomad				
	4-pt Medium	✓	✓	✓
Nova				
	2-pt Small	✓		
	2-pt Medium	✓	✓	
	2-pt Large		✓	✓
	4-pt Medium		✓	✓
	4-pt Large			✓

Valg af sejl

Den størrelse, du skal vælge, afhænger af brugerens vægt, funktion og kropsstørrelse/-omkreds. Sikker arbejdsbelastning (SWL, Safe Working Load) er 300 kg.

Fejlfinding

Symptom	Mulig årsag/udbedring
Sejlet passer ikke til brugeren.	Forkert sejlstørrelse. Prøv med en anden størrelse.
	Sejlet er for lille, når benstøtterne ikke kan nå halvvejs rundt om inderlåret, og ophænget befinder sig for tæt på brugerens ansigt. Prøv med en anden størrelse.
	Sejlet er ikke korrekt placeret. Træk sejlet tilstrækkeligt langt ned bagtil, når du placerer det.
Alle stropperne løfter ikke samtidigt.	Hvis sejlstropperne løfter ujævnt, betyder det, at sejlet kan glide op bagpå, hvilket kan resultere i, at brugeren glider ned i åbningen på sejlet. Sørg for, at benstøtterne er korrekt placeret på lårene.

Suomenkielinen käyttöopas

Sisältö

Yleistä.....	44
Testaus ja takuu	44
Turvallisuusohjeet	45
Tarkastus	45
Määräaikaistarkastus.....	45
Kuvaus.....	46
Etac Molift RgoSling Comfort HighBack.....	46
Huolto/pesu	46
Nostoliinan käyttö makuuasennossa	48
Nostaminen	49
Siirtää	49
Nostoliinan säätäminen ja tarkastettavat kohdat	50
Nostoliinan poistaminen	51
Yhdistelmätaulukko	52
Nostoliinan koko-opas	52
Ohjeita ongelmatilanteisiin.....	53

Yleistä

Kiitos, että valitsit Etacin Molift-nostoliinan.

Lue käyttöopas huolellisesti, jotta vältetään vauriot tuotteen käsittelyn ja käytön yhteydessä.

Tässä käyttöoppaassa käyttäjällä tarkoitetaan nostettavaa henkilöä.

Avustaja on nostoliinaa ohjaava henkilö.



Tämä kuvake näkyy käyttöoppaassa yhdessä tekstin kanssa. Se osoittaa, että on toimittava varovasti, koska muutoin käyttäjän tai avustajan turvallisuus voi vaarantua.

Etac tekee jatkuvasti parannuksia tuotteisiinsa. Pidätämme siksi oikeuden muuttaa tuotteita ilman aiempaa ilmoitusta.



Osoitteesta www.molift.com saat lisätietoja, ohjeita ja ajantasaisimmat dokumentit.

Emme vastaa painovirheistä tai puuttuvista tiedoista.

Testaus ja takuu

CE Tämä tuote on CE-merkitty.

Etac Molift -nostoliinat on testattu hyväksytyjen testauslaitosten toimesta, ja ne ovat luokan 1 lääkinnällisiä laitteita koskevan direktiivin MDR (EU) 2017/745 mukaisia. Nostoliinat ovat standardin EN ISO 10535 vaatimusten mukaisia.

Takuu: Kaksi vuotta materiaali- ja valmistusvirheille asianmukaisessa käytössä.

Tutustu Etac Molift -nostoliinoiden ja -nostolaitteiden tuotevalikoimaan osoitteessa www.molift.com.

Turvallisuusohjeet

sessä käytettävä lomake löytyy osoitteesta www.molift.com.

Huomaa



Lue sekä nostolaitteen että nostoliinan käyttöopas huolellisesti ennen käyttöä vaurioiden välttämiseksi tuotteen käsittelyn ja käytön yhteydessä.

Nostoliina tulee testata yksittäistä käyttäjää ja nostotilanteen käyttötarkoitusta varten. Varmista, tarvitaanko nostotilanteessa yksi avustaja vai useampia avustajia.

Suunnittele nostotoimenpide etukäteen, jotta voidaan varmistaa, että nostaminen tapahtuu turvallisesti ja sujuvasti. Työskentele ergonomisesti.

Arvioi riskit ja tee muistiinpanoja. Hoitohenkilöstö on vastuussa käyttäjän turvallisuudesta.



Älä koskaan nosta käyttäjää tarpeettoman korkealle aloituspisteestä noston yhteydessä. Älä koskaan jätä käyttäjää ilman valvontaa nostotilanteessa.



Tarkasta aina seuraavat:

- Kyseinen nostoliina soveltuu käyttäjälle.
- Malli, koko ja materiaali ovat sopivat.
- Nostoliina soveltuu käytettävälle nostolaitteelle/ripustukselle.
- Nostolenkit on kiinnitetty oikein ripustuksen koukkuihin ennen käyttäjän nostamista.
- Pyörätuolin tai sängyn pyörät on tarvittaessa lukittu siirtämisen ajaksi.

Tarkastus

- Nostoliina tulee tarkastaa säännöllisesti, mieluiten ennen jokaista nostotilannetta ja erityisesti aina pesun jälkeen.
- Tarkasta, että saumoissa, kankaassa, hihnoissa ja lenkeissä ei ole kulumia tai vaurioita.



Älä koskaan käytä viallista tai vaurioitunutta nostoliinaa, koska se voi mennä rikki ja aiheuttaa henkilövahinkoja. Hävitä ja poista käytöstä vaurioituneet ja vanhat nostoliinat.



Älä varastoi nostoliinaa suorassa auringonvalossa.

Määräaikaistarkastus

Määräaikaistarkastus tulee tehdä vähintään 6 kuukauden välein. Säännöllisempi tarkastus voi olla tarpeen, jos nostoliinaa käytetään tai pestään normaalia useammin. Säännöllisessä tarkastuk-

Kuvaus

Etac Molift -valikoimasta löytyy nostoliinoja erityyppisiä siirtoja varten. Molift RgoSling on suunniteltu niin, että paino ja paine jakautuvat tasaisesti, jotta tuotetta on mahdollisimman miellyttävä käyttää.

Nostoliinan ylempiä ripustuslenkkejä voidaan liukusäätää, joten nostoliina pysyy tasapainossa koko siirron ajan. Näin nostaminen sujuu käyttäjäystävällisesti ja miellyttävästi.

Ohjauslenkin avulla käyttäjä on helppo asettaa asianmukaiseen istuma-asentoon. Ohjauslenkkiä käytetään vain käyttäjää nostettaessa.

Molift RgoSling on suunniteltu yhdistettäväksi 4-pisteripustukseen, mutta nostoliinaa voidaan käyttää myös 2-pisteripustuksen kanssa. Katso oikeat nostoliinojen ja ripustusten yhdistelmät yhdistelmäluettelosta.

Molift RgoSling Comfort HighBack -tuotteesta on saatavilla koot S–L, materiaalina polyesteriverkko.

Molift RgoSling Comfort HighBack Pehmustomaton nostoliina, joka mukautuu kehon muotojen mukaan. Nostoliina on tarkoitettu jätettäväksi käyttäjän alle noston ja siirron jälkeen. Tuote on valmistettu hengittävää polyesteriverkosta. Nostoliina voidaan pukea vain, kun käyttäjä on makuuasennossa. Kädet asetetaan nostoliinan sisäpuolelle. Nostoliina antaa miellyttävän istuma-asennon ja tukee täysin päätä ja vartaloa.

Tuotteen arvioitu käyttöikä on 1–5 vuotta normaalissa käytössä. Tuotteen käyttöikä vaihtelee käyttö- ja pesutiheyden, materiaalien sekä kuormituksen mukaan.

- A1. Tuotetarra
- A2. (01) EAN-koodi
xxxxxxxxxxxxxxx
(21) Sarjanumero
xxxxxxx
- A3. QR-koodi
- A4. Merkki: Määräaikaistarkastus
- A5. Merkki: Käyttäjän nimi
- A6. Ylempi nostolenkki
- A7. Sivussa oleva ohjauslenkki
- A8. Alempi nostolenkki
- A9. Kuvake: Lue käyttöopas ennen käyttöä
- A10. Kuvake: Käyttäjän enimmäispaino
- A11. Kuvake: Tämä puoli tuotteesta käännetään ylöspäin ja ulospäin
- A12. Kuvake: Avaa ja lue lisätietoja

Huolto/pesu

Lue tuotteessa olevat huolto-ohjeet.

1. Vesipesun kestävät nostoliinat voidaan pestä 60–85 °C:n lämpötilassa.



Pesu korkeammissa lämpötiloissa kuluttaa materiaalia nopeammin.

2. Rumpukuivaus enintään 45 °C:ssa. Voidaan desinfioida autoklaavissa 85 asteessa 30 minuutin ajan.
3. Ei saa kuivapestä..
4. Ei saa valkaista.
5. Ei saa silittää.

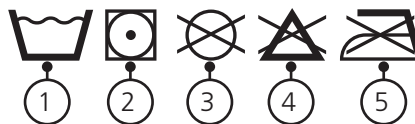

Symboleja:



Valmistaja



Tämä puoli ylöspäin, tämä puoli ulospäin



Valmistuspäivä. VVVV-KK-PP (vuosi/kuukausi/päivä)



Käyttäjän enimmäispaino



CE-merkintä



Lääkinnällinen laite



Katso käyttöopas

A

RgoSling Comfort HighBack

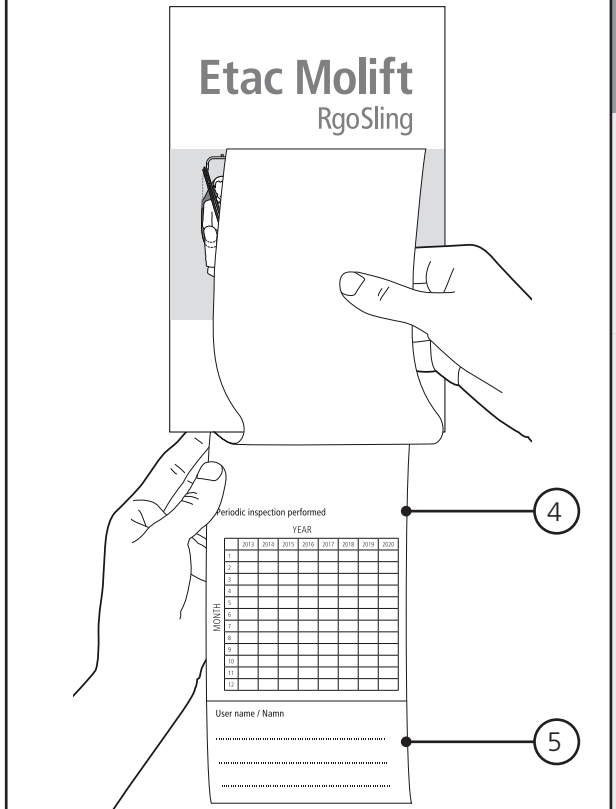
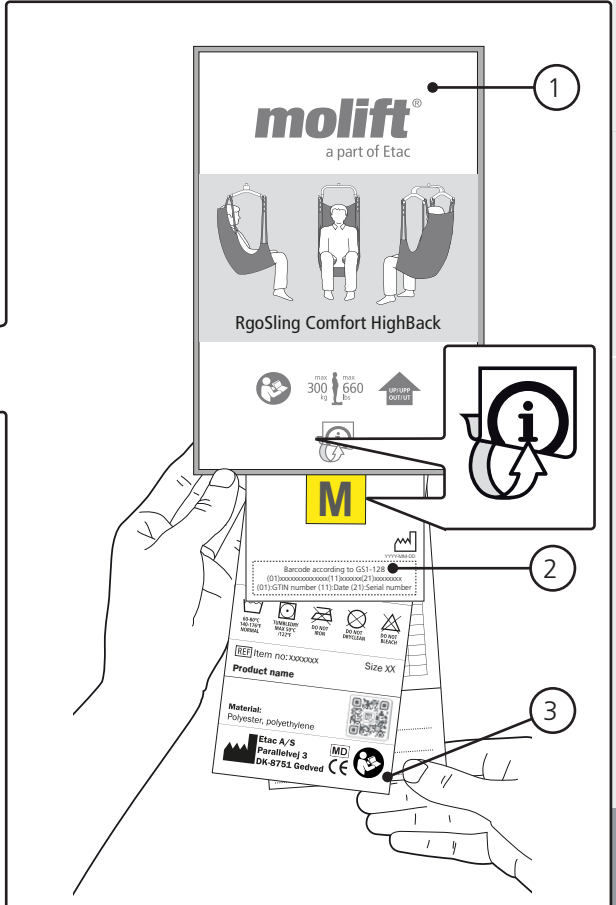
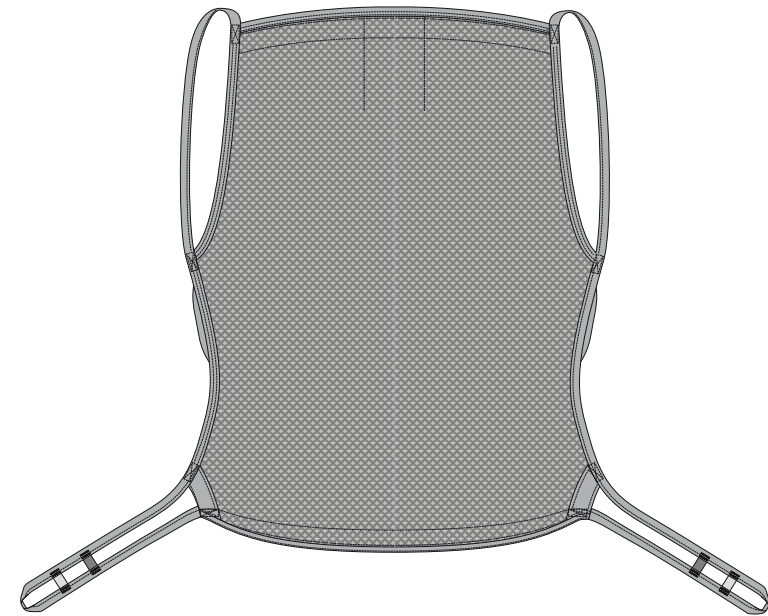
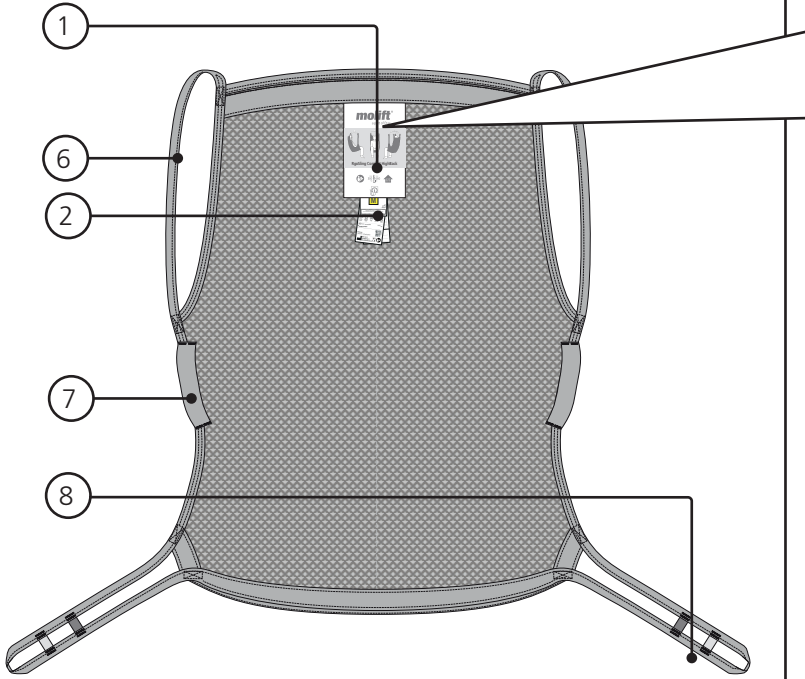

molift®
a part of Etac

RgoSling Comfort HighBack

max 300 kg / max 660 lbs

UP/UPP
OUT/UT

Barcode according to GS1-128
(0) Manufacturer's Plant and P2 Accessory
(10) GS1 TN number (1) Date (2) Serial number

HEM Heim no: XXXXXX Size XX

Product name

Material: Polyester, polyethylene

Etac A/S
Parallevej 2
DK-8752 Gedved

Etac Molift RgoSling

Periodic inspection performed

MONTH	YEAR											
	2013	2014	2015	2016	2017	2018	2019	2020				
1												
2												
3												
4												
5												
6												
7												
8												
9												
10												
11												
12												

User name / Navn

B

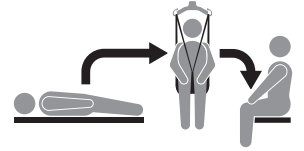

Nostoliinan käyttö

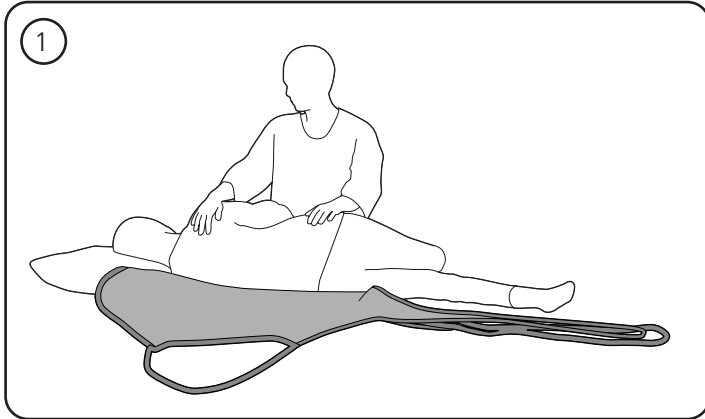

B1. Käännä käyttäjää itseäsi kohti niin, että hän makaa turvallisesti kyljellään. Taita nostoliina keskeltä ja aseta se käyttäjän selän taakse.

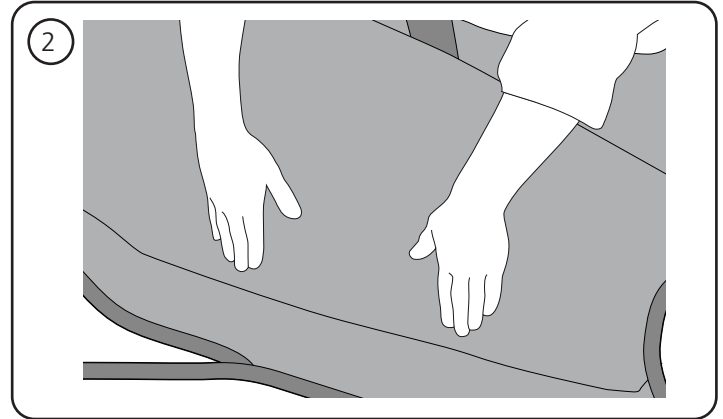

B2. Käännä käyttäjä vastakkaiselle kyljelle ja vedä nostoliinaa eteenpäin. Varmista, että käyttäjä on nostoliinan keskellä. Jos sängyssä on selkätuki, voit hyödyntää sitä. Ole varovainen, kun asetat käyttäjän vastakkaiselle kyljelle. Varmista, että käyttäjä ei pääse kierähtämään ja putoamaan sängystä.

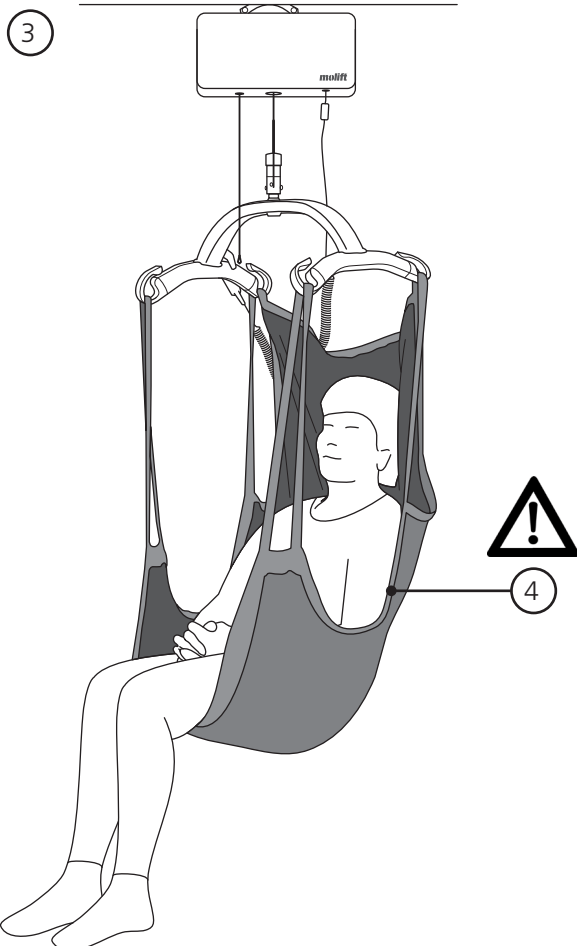

B3. Älä aseta jalkatukia ristikkäin. Jos käyttäjän ylävartalo on epävakaata tai spastinen (lihasten tahaton kouristelu), vaarana voi olla, että käyttäjä putoaa nostoliinasta päälle. Tässä tapauksessa suosittelemme mahdollisimman nojaavaa asentoa, jolloin voidaan käyttää alempien nostolenkkien sisempiä kiinnityspisteitä.

B4. Ohjauslenkin avulla käyttäjä on helppo asettaa asianmukaiseen istuma-asentoon. Ohjauslenkkiä käytetään vain käyttäjää nostettaessa. Tätä lenkkiä ei saa käyttää nostamiseen!

Nostaminen

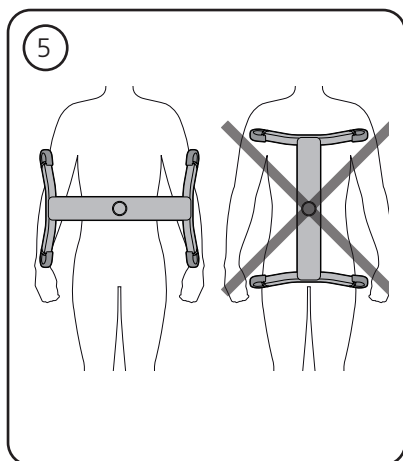

B5. Ripustus on aina asetettava poikittain käyttäjään nähden, jotta estetään käyttäjän liukuminen pois nostoliinasta.

B6. Kiinnitä nostoliina ripustuksen koukkuihin.

B7. Venytä nostoliinan lenkkejä käyttäjää nostamatta. Varmista, että nostoliina on asetettu

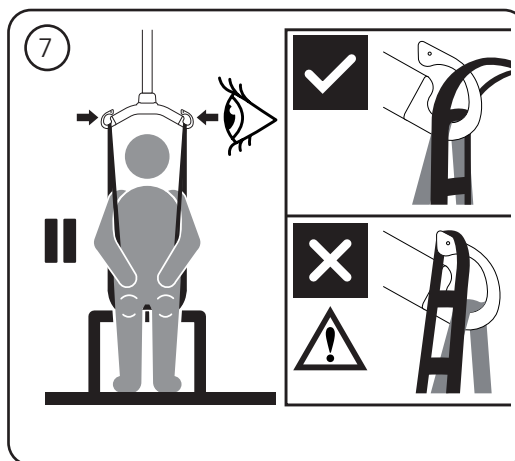
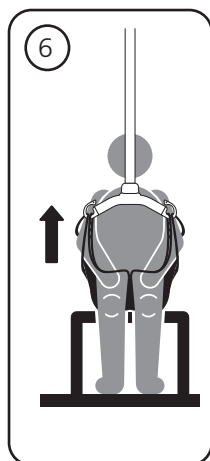

oikein käyttäjän ympärille ja että nostolenkit on kiinnitetty oikein ripustuksen koukkuihin.

B8. Älä nosta käyttäjää korkeammalle kuin on tarpeen. Muista, että siirrettävän nostolaitteen pyörät EIVÄT saa olla lukittuina.

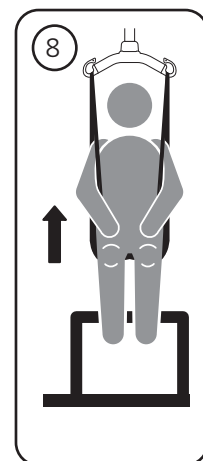

Laskeminen istuma-asentoon

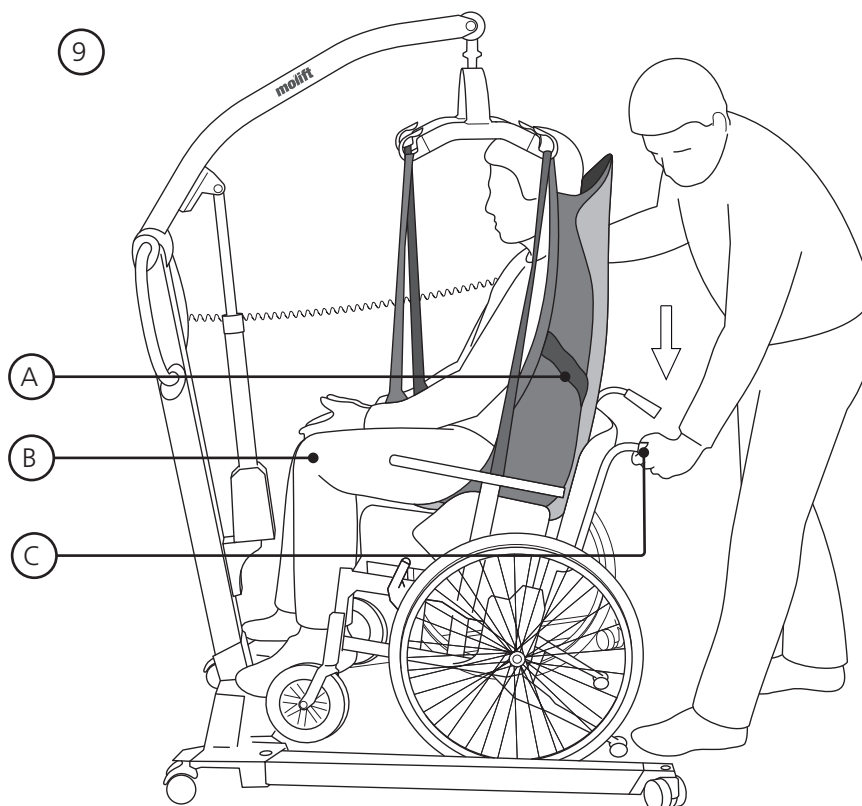

B9. Kun käyttäjä siirretään istuma-asentoon, voit käyttää seuraavia tekniikoita käyttäjän laskemiseen mahdollisimman taakse istuimeen:

A. Aseta käyttäjä oikeaan asentoon ohjauslenkin avulla.

B. Työnnä käyttäjän polvia kevyesti.

C. Kallista istuinta taaksepäin.

C

Nostoliinan säätäminen ja tarkastettavat kohdat

RgoSling Comfort HighBack

C1. Ripustus on käyttäjän kasvoista poispäin.

C2. Päätuکی ei ole liian alhaalla.

Nostoliina tulee asettaa käyttäjän päätä korkeammalle.

C3. Nostoliina on asetettu hyvin käyttäjän reisien alle.

C4. Älä aseta alempia nostolenkkejä ristikkäin.

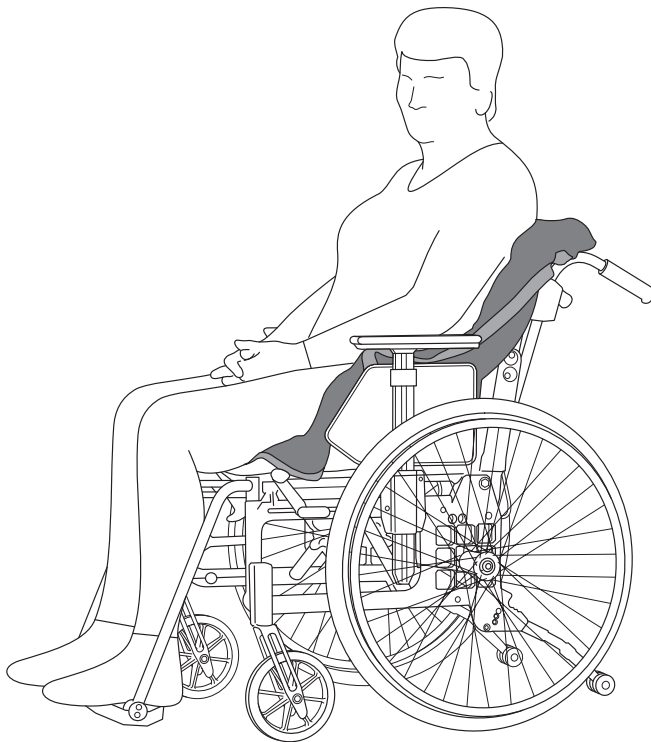
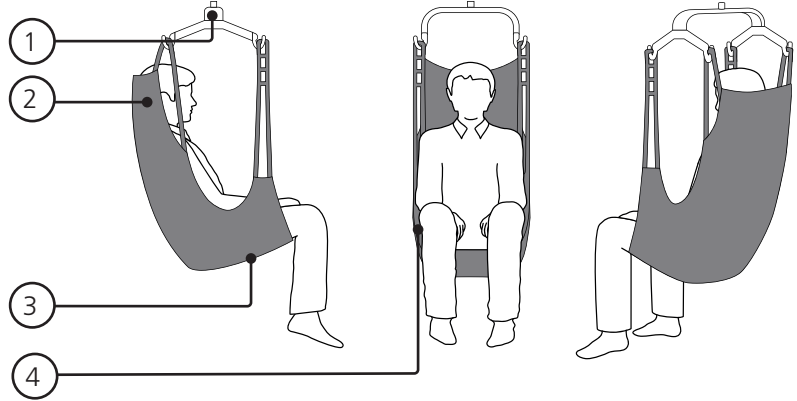

C5. Nostoliina on tarkoitettu jätettäväksi käyttäjän alle siirron jälkeen.



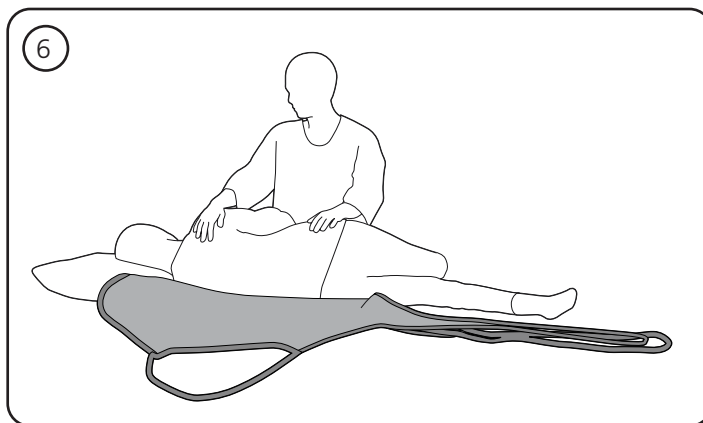





Nostoliinan riisuminen

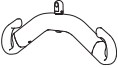
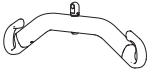
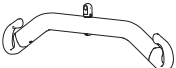

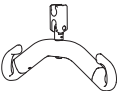
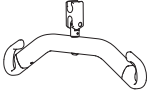
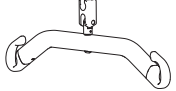



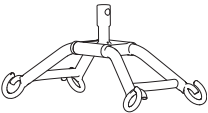
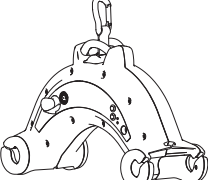

C6. Vapauta nostolenkit ripustuksesta. Käännä käyttäjää itseäsi kohti niin, että hän makaa turvalisestisesti kyljellään. Taita nostoliina keskeltä ja aseta se käyttäjän selän taakse. Käännä käyttäjä vastakkaiselle kyljelle ja vedä nostoliina pois. Ole varo-

vainen, kun asetat käyttäjän vastakkaiselle kyljelle. Varmista, että käyttäjä ei pääse kierähtämään ja putoamaan sängystä.

Yhdistelmäluettelo

Ripustus		RgoSling Comfort HighBack		
		S	M	L
Mover 180				
	2-pt Small	✓		
	2-pt Medium	✓	✓	
	2-pt Large		✓	✓
	4-pt Medium	✓	✓	✓
	4-pt Large		✓	✓
Mover 205				
	2-pt Small	✓		
	2-pt Medium	✓	✓	
	2-pt Large		✓	✓
	4-pt Medium	✓	✓	✓
	4-pt Large		✓	✓
Mover 300				
	4-pt Medium	✓	✓	✓
	4-pt Large		✓	✓
Partner 255				
	4-pt Medium	✓	✓	✓
	4-pt Large		✓	✓

Ripustus		RgoSling Comfort HighBack		
		S	M	L
Smart				
	4-pt Medium	✓	✓	✓
Nomad				
	4-pt Medium	✓	✓	✓
Nova				
	2-pt Small	✓		
	2-pt Medium	✓	✓	
	2-pt Large		✓	✓
	4-pt Medium		✓	✓
	4-pt Large			✓

Nostoliinan koko-opas

Valittava koko riippuu osittain käyttäjän painosta, käyttötarkoituksesta ja vartalon ympärysmitasta/koosta.

Turvallinen työkuormitus (SWL) 300* kg.

Ohjeita ongelmatilanteisiin

Ongelma	Mahdollinen syy/toimenpide
Nostoliina ei sovi käyttäjälle.	Vääränkokoinen nostoliina. Kokeile toista kokoa.
	Nostoliina on liian pieni, jos jalkatuet eivät ylety sisäreiden puoleenväliin ja ripustus on liian lähellä käyttäjän kasvoja. Kokeile toista kokoa.
	Nostoliina on asetettu väärään kohtaan. Vedä nostoliinaa takaosasta riittävästi alaspäin, kun asetat sitä käyttäjälle.
Kaikki lenkit eivät nosta samanaikaisesti.	Jos nostoliinan hihnat nostavat epätasaisesti, nostoliina voi liukua ylös selästä, jolloin käyttäjä saattaa liukua alas nostoliinan aukosta. Varmista, että jalkatuet on asetettu oikein reisien päälle.

EN

SV

NO

DA

FI

DE

NL

FR

IT

ES

Deutsche Bedienungsanleitung

Inhalt

Allgemeines	54
Test und Garantie	54
Sicherheitsmaßnahmen	55
Inspektionen.....	55
Regelmäßige Inspektion	55
Beschreibung	56
Etac Molift RgoSling Comfort HighBack.....	56
Pflege/Waschen	56
Anbringen des Hebetuchs im Liegen	58
Heben.....	59
In eine Sitzposition absenken	59
Einstellungen am Hebetuch und zu überprüfende Punkte	60
Entfernen des Hebetuchs.....	61
Verzeichnis der Kombinationsmöglichkeiten	62
Wahl des passenden Hebetuchs.....	62
Fehlersuche und -behebung	63

Test und Garantie

CE dieses Produkt ist CE-zertifiziert.

Die Molift-Hebetücher von Etac wurden von anerkannten Prüfstellen geprüft und entsprechen den in der Medizinprodukterichtlinie MDR (EU) 2017/745 formulierten Anforderungen für Produkte der Klasse 1. Darüber hinaus erfüllen die Hebetücher die in der Norm EN ISO 10535 aufgeführten Anforderungen.

Garantie: Zwei Jahre auf Material- und Herstellungsfehler bei ordnungsgemäßem Gebrauch.

Weitere Informationen über das Angebot an Molift-Hebetüchern und -Liftern von Etac finden sie auf www.molift.com

Allgemeines

Danke, dass Sie sich für ein Molift-Hebetuch von Etac entschieden haben.

Die Bedienungsanleitung muss sorgfältig gelesen werden, um Beschädigungen bei Handhabung und Gebrauch des Produkts zu vermeiden.

In dieser Bedienungsanleitung ist der „Benutzer“ diejenige Person, die gehoben wird. Der „Helfer“ ist diejenige Person, die das Hebetuch bedient.



Dieses Symbol ist in der Bedienungsanleitung mit dazugehörigem Text zu finden. Es zeigt an, dass Vorsicht geboten ist, wenn die Sicherheit des Benutzers oder des Helfers gefährdet ist.

Etac arbeitet kontinuierlich an der Verbesserung seiner Produkte. Wir behalten uns deshalb das Recht vor, jederzeit Änderungen an unseren Produkten ohne vorherige Ankündigung vorzunehmen.



Weitere Informationen, Beratung und aktuelle Dokumentationen finden Sie auf www.molift.com

Wir übernehmen keine Haftung für Druckfehler oder unvollständige Angaben.

Sicherheitsmaßnahmen



Die Bedienungsanleitungen für den Lifter als auch für das Hebetuch müssen vor Gebrauch sorgfältig gelesen werden, um Verletzungen während Handhabung und Gebrauch des Produkts zu vermeiden.

Es ist wichtig, dass das Hebetuch mit jedem einzelnen Benutzer und für jede Hebesituation individuell getestet wird. Entscheiden Sie, ob mehr als ein Helfer benötigt wird.

Planen Sie den Hebetransport im Voraus, um sicherzustellen, dass alles so sicher und störungsfrei wie nur möglich abläuft. Denken Sie an eine ergonomische Arbeitsweise.

Bewerten Sie die Risiken und machen Sie sich entsprechende Notizen. Sie als Pfleger/Betreuer sind für die Sicherheit des Benutzers verantwortlich.



Heben Sie einen Benutzer niemals vom Startpunkt aus höher an, als für die Durchführung des Hebetransports unbedingt notwendig ist. Lassen Sie den Benutzer während des Hebetransports niemals unbeaufsichtigt.



Stellen Sie stets sicher, dass der Benutzer über die erforderlichen Fähigkeiten zur Benutzung des betreffenden Hebetuchs verfügt,

- Modell, Größe und Material sind geeignet
- Das Hebetuch eignet sich für den eingesetzten Lifter bzw. die eingesetzte Aufhängung.
- Es ist wichtig, vor dem Heben des Benutzers sicherzustellen, dass die Hebeschlaufen ordnungsgemäß an den Haken der Aufhängung befestigt sind.
- Stellen Sie sicher, dass die Räder von Rollstuhl, Bett oder Bahre während des Hebetransports verriegelt sind, soweit erforderlich.

Inspektionen

Das Hebetuch muss regelmäßig untersucht werden, vorzugsweise vor jedem Hebetransport, vor allem aber nach jedem Waschen.

- Stellen Sie dabei sicher, dass Nähte, Stoff, Bänder und Schlaufen nicht verschlissen oder beschädigt sind.



Benutzen Sie niemals ein fehlerhaftes oder beschädigtes Hebetuch, da dies reißen und zu Verletzungen führen kann. Zerstören und entsorgen Sie beschädigte und alte Hebetücher



Das Hebetuch sollte nicht in direktem Sonnenlicht gelagert werden.

Regelmäßige Inspektion

Die regelmäßige Inspektion muss mindestens alle 6 Monate durchgeführt werden. Wenn das Hebetuch über den normalen Gebrauch hinaus öfters eingesetzt oder gewaschen wird, ist es ggf. notwendig, die Inspektionen häufiger durchzuführen. Informationen zur regelmäßigen Inspektion finden Sie auf www.molift.com

Beschreibung

Der Molift von Etac bietet eine breite Auswahl von Hebetüchern für Transportaufgaben aller Art an. Das Hebetuch Molift RgoSling von Etac ist darauf ausgelegt, Gewicht und Druck im Hinblick auf größtmöglichen Komfort gleichmäßig zu verteilen.

Die oberen Aufhängungsschlaufen des Hebetuchs sind verschiebbar, sodass sich das Hebetuch während des ganzen Transports im Gleichgewicht befindet. Dies sorgt für hohen Benutzerkomfort und einen angenehmen Transport.

Mit Hilfe eines Führungsgriffs kann der Benutzer in die richtige Sitzposition gebracht werden. Er kommt ausschließlich dann zum Einsatz, wenn sich der Benutzer im Hebemodus befindet. Das Hebetuch Molift RgoSling von Etac kann sowohl mit einer 4-Punkt-Aufhängung als auch mit einer 2-Punkt-Aufhängung kombiniert werden. Die korrekten Kombinationsmöglichkeiten für die einzelnen Hebetücher und Aufhängungen finden Sie im Verzeichnis der Kombinationsmöglichkeiten.

Das Hebetuch Molift RgoSling Comfort Highback ist in den Größen S – L mit Polyesternetzgewebe erhältlich.

Molift RgoSling Comfort HighBack

Es ist ein Hebetuch ohne Polster, das sich dem Körper anpasst. Das Hebetuch ist so konzipiert, dass es nach der Verwendung des Lifters unter dem Benutzer bleibt, wenn die Bewegung beendet wurde. Es besteht aus einem Polyesternetzgewebe, die Körperfeuchtigkeit und Wärme durchlässt. Damit das Hebetuch verwendet werden kann, muss sich der Benutzer in liegender Position befinden. Die Arme werden dazu im Hebetuch positioniert. Dabei bietet das Hebetuch eine komfortable Sitzposition und stützt den Kopf und den Körper optimal.

Das Produkt hat eine voraussichtliche Lebensdauer von 1 bis 5 Jahren bei normalem Gebrauch. Die Lebensdauer des Produkts variiert und hängt von der Häufigkeit des Gebrauchs, der Materialbeschaffenheit, der Belastung und davon ab, wie oft es gewaschen wird.

- A1. Produktetikett
- A2. (01) EAN-code
xxxxxxxxxxxxxxxx
(21) Seriennummer
xxxxxxx
- A3. QR-Code
- A4. Etikett: Regelmäßige Inspektion
- A5. Etikett: Benutzername
- A6. Obere Hebeschlaufen
- A7. Führungsgriff, seitlich
- A8. Untere Hebeschlaufen
- A9. Symbol: Vor dem Gebrauch die Bedienungsanleitung lesen
- A10. Symbol: Maximales Benutzergewicht
- A11. Symbol: Diese Seite des Produkts wird nach oben und nach außen gedreht
- A12. Symbol: Aufklappen - Weitere Informationen befinden sich auf der Innenseite

Pflege/Waschen

Lesen Sie die Pflegeanweisungen für das Produkt.

1. Mit Wasser waschbare Hebetücher können bei Temperaturen von 60° C bis 85° C gewaschen werden.



Waschen bei höheren Temperaturen hat einen schnelleren Materialverschleiß zur Folge.

2. Trockenschleudern bei max. 45° C. Sterilisation für 30 Minuten bei 85 °C
3. Nicht chemisch reinigen.
4. Nicht bleichen.
5. Nicht bügeln.

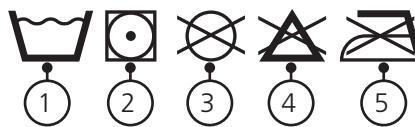

Symbole:



Hersteller



Herstellungsdatum: JJJJ-MM-DD (Jahr/Monat/tag)



Hier oben, diese Seite ist außen



Max. Benutzergewicht (Tragfähigkeit)



CE-konform



Medizinprodukt



Lesen Sie die Bedienungsanleitung

EN
SV
NO
DA
FI
DE
NL
FR
IT
ES

A

RgoSling Comfort HighBack

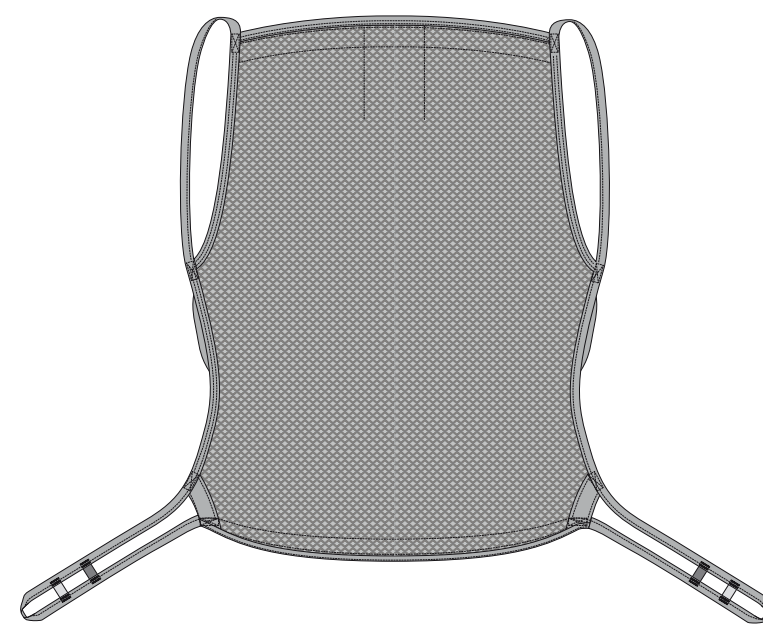
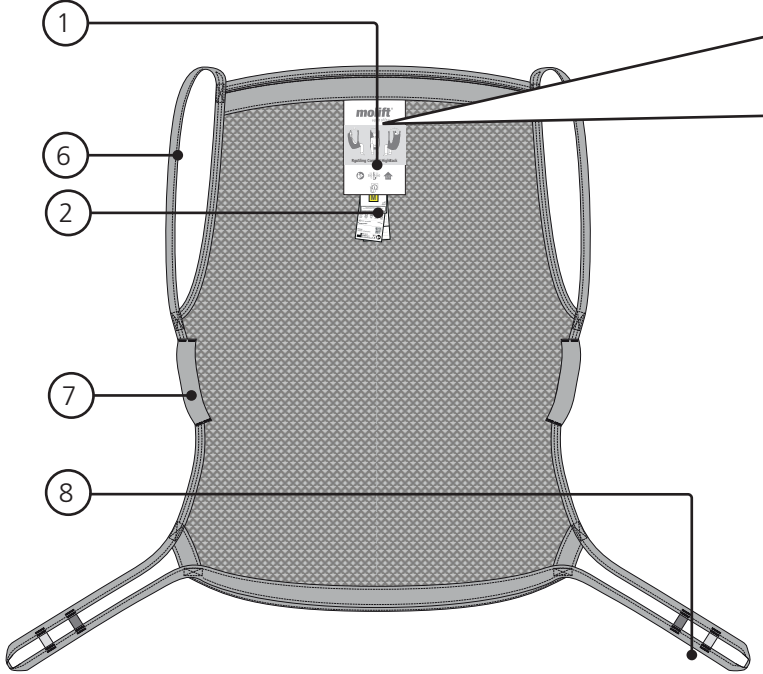

1

2

3

4

5

6

7

8

9

10

11

12

molift®
a part of Etac

RgoSling Comfort HighBack

max 300 kg max 660 lbs UP/UPP OUT/UT

Barcode according to GS1-128
(01: GTIN number (11); Date (2); Serial number)

REF Item no.: 20030000 Size XX

Product name

Material: Polyester, polyethylene

Etac A/S
Parallevej 3
DK-8751 Gedved

Periodic inspection performed

MONTH	YEAR												
	2013	2014	2015	2016	2017	2018	2019	2020	2021	2022	2023	2024	
1													
2													
3													
4													
5													
6													
7													
8													
9													
10													
11													
12													

User name / Namn

B

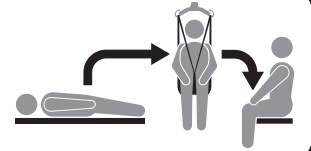

Anbringen des Hebetuchs im Liegen

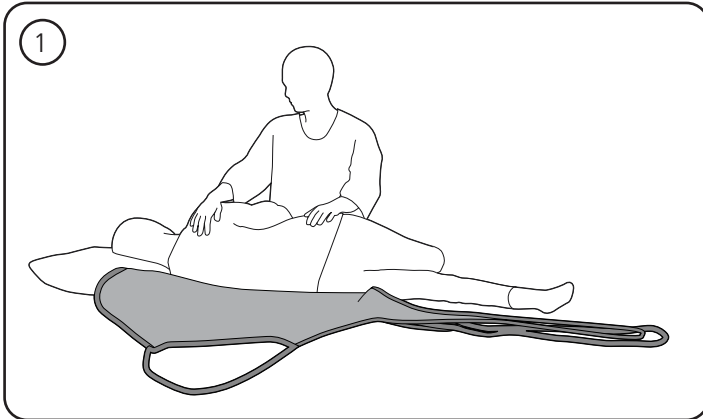

B1. Drehen Sie den Benutzer zu sich und bringen Sie ihn in die stabile Seitenlage. Falten Sie das Hebetuch in der Mitte und legen Sie es hinter den Rücken des Benutzers.

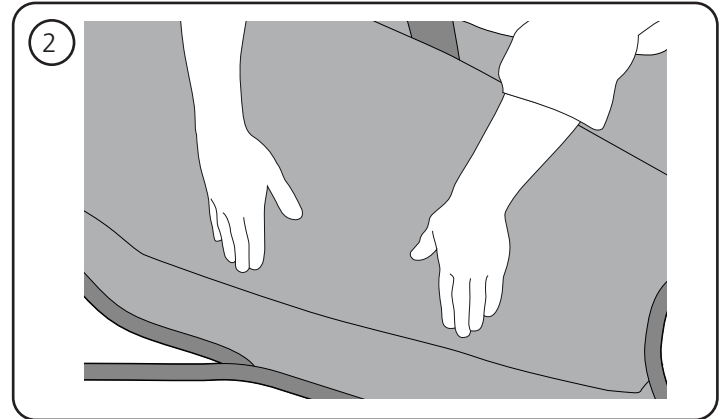

B2. Drehen Sie dann den Benutzer auf die andere Seite und ziehen Sie das Hebetuch hervor. Achten Sie darauf, dass der Benutzer in der Mitte des Hebetuches liegt. Wenn das Bett eine Rückenlehne hat, kann diese benutzt werden.

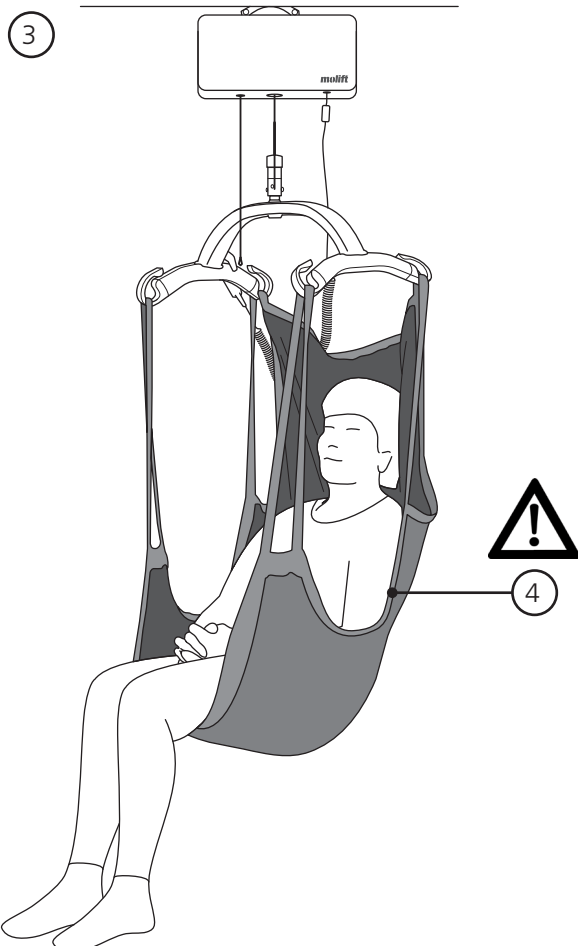

B3. Überkreuzen Sie die Oberschenkelauflagen nicht. Falls der Benutzer einen instabilen Rumpf hat oder spastisch ist (unfreiwillige Muskelkontraktionen), kann dies ein Risiko darstellen, kopfüber aus dem Hebetuch zu fallen. In diesem Fall empfehlen wir dem Benutzer, sich so weit wie möglich zurückzulehnen, und die inneren Befestigungspunkte für die unteren Hebegurte zu verwenden.

B4. Mit Hilfe eines Führungsgriffs kann der Benutzer in die richtige Sitzposition gebracht werden. Er kommt ausschließlich dann zum Einsatz, wenn sich der Benutzer im Hebemodus befindet. Dies ist keine Gurtschleife zum Heben

Lifting

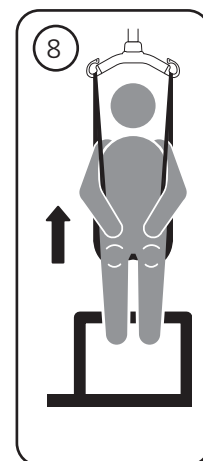
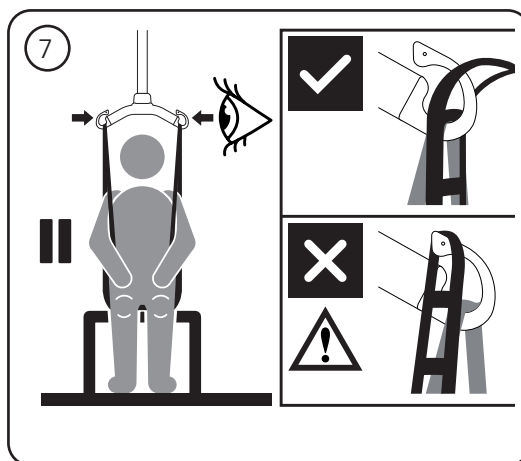
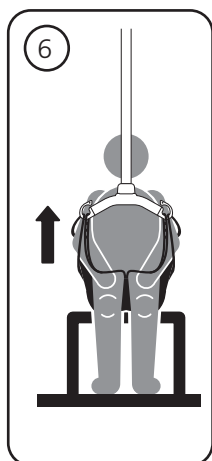
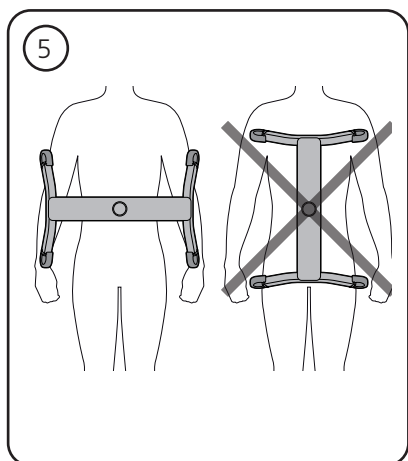

- B5. Die Aufhängung muss immer horizontal zum Benutzer ausgerichtet sein, um zu verhindern, dass der Benutzer aus dem Hebetuch rutscht.
- B6. Hängen Sie das Hebetuch in die Haken der Aufhängung ein.
- B7. Ziehen Sie die Schlaufengurte des Hebetuchs an, ohne dabei den Benutzer anzuheben. Stellen Sie sicher, dass das Hebetuch

ordnungsgemäß am Benutzer anliegt und die Gurtschlaufen ordnungsgemäß an den Aufhängungshaken befestigt sind.

- B8. Heben Sie den Benutzer nur soweit an, wie es notwendig ist. Vergessen Sie nicht, dass die Räder eines mobilen Lifters NICHT blockiert sein dürfen.

In eine Sitzposition absenken

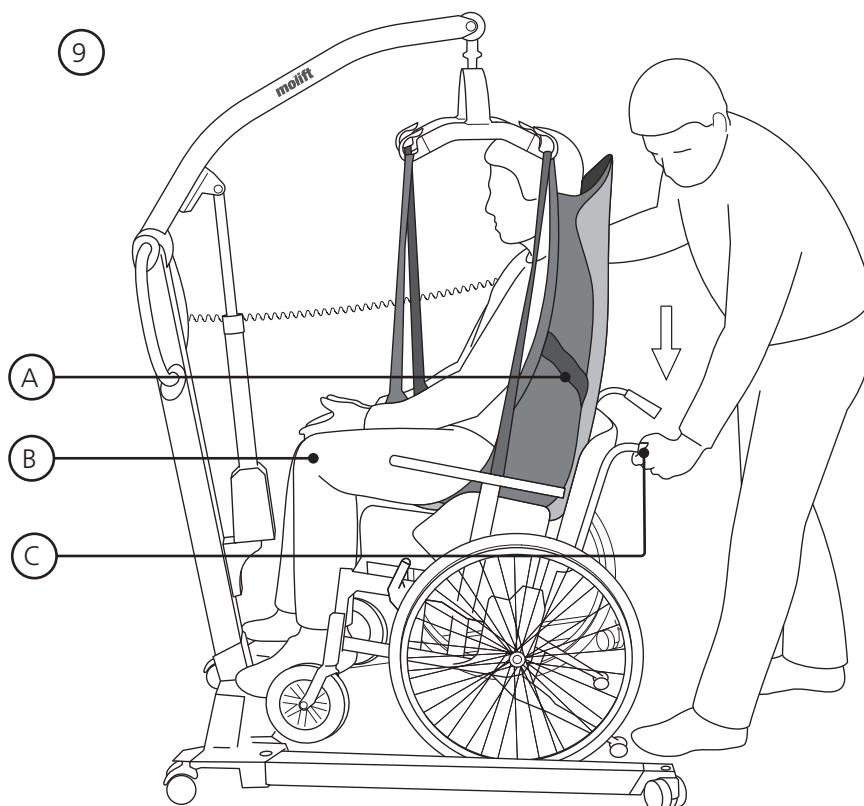

- B9. Um den Benutzer in eine Sitzposition zu bringen, können die folgenden Techniken angewandt werden, während der Benutzer so weit wie möglich zurück in den Sitz abgesenkt wird:

- A. Positionieren Sie den Benutzer mithilfe des Steuergriffs
- B. Drücken Sie sanft gegen die Knie des Benutzers
- C. Neigen Sie den Sitz nach hinten

C

Einstellungen am Hebetuch und zu überprüfende Punkte

RgoSling Comfort HighBack

- C1. Stellen Sie sicher, dass die Aufhängung nicht in der Nähe des Gesichts des Benutzers ist
- C2. Stellen Sie sicher, dass die Kopfstütze nicht zu niedrig angebracht ist. Das Hebetuch sollte höher als der Kopf des Benutzers positioniert sein.
- C3. Stellen Sie sicher, dass das Hebetuch ordnungsgemäß unter den Oberschenkeln positioniert ist.
- C4. Überkreuzen Sie nicht die unteren Hebeschlaufen

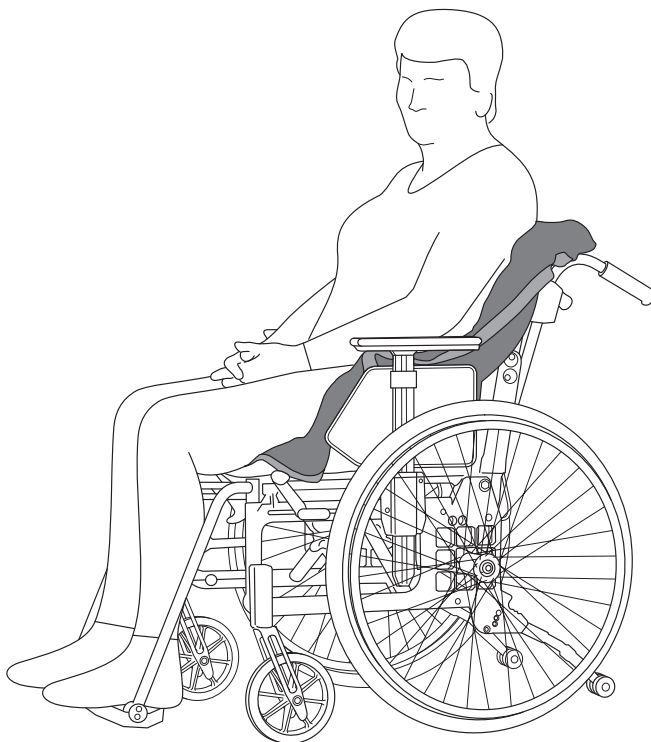
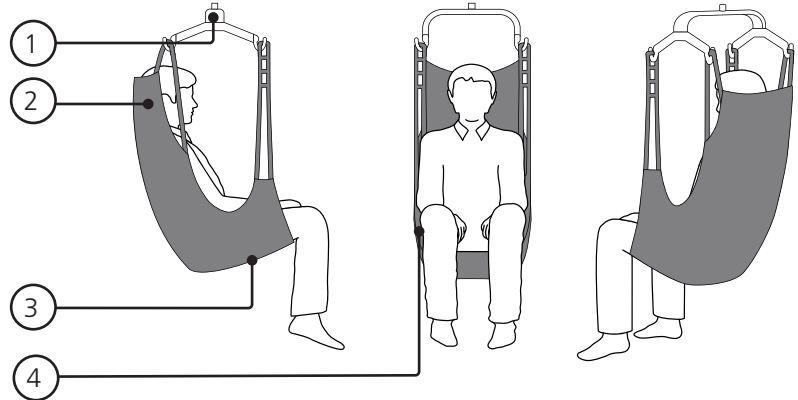

- C5. Das Hebetuch sollt nach dem Umsetzen unter dem Benutzer belassen werden



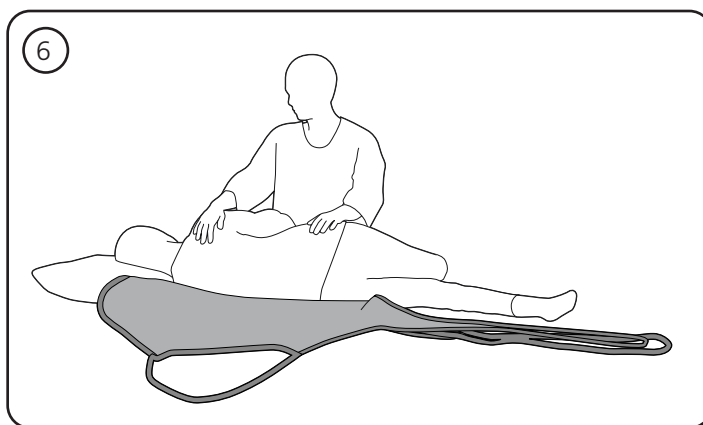





Entfernen des Hebetuchs

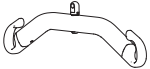
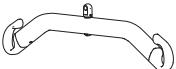

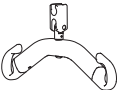
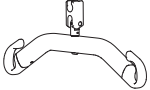
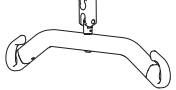



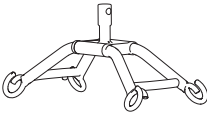
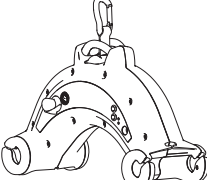

C6. Lösen Sie die Schlaufen von der Aufhängung. Drehen Sie den Benutzer zu sich und bringen Sie ihn in die stabile Seitenlage. Falten Sie das Hebetuch in der Mitte und legen Sie es hinter den Rücken des Benutzers. Drehen Sie den Benutzer auf die andere Seite und

ziehen Sie das Hebetuch weg. Seien Sie beim Umpositionieren des Benutzers zur anderen Seite hin vorsichtig. Stellen Sie sicher, dass er sich dabei nicht überschlägt und aus dem Bett fällt.

Verzeichnis der Kombinationsmöglichkeiten

Aufhängung		RgoSling Comfort HighBack		
		S	M	L
Mover 180				
	2-pt Small	✓		
	2-pt Medium	✓	✓	
	2-pt Large		✓	✓
	4-pt Medium	✓	✓	✓
	4-pt Large		✓	✓
Mover 205				
	2-pt Small	✓		
	2-pt Medium	✓	✓	
	2-pt Large		✓	✓
	4-pt Medium	✓	✓	✓
	4-pt Large		✓	✓
Mover 300				
	4-pt Medium	✓	✓	✓
	4-pt Large		✓	✓
Partner 255				
	4-pt Medium	✓	✓	✓
	4-pt Large		✓	✓

Aufhängung		RgoSling Comfort HighBack		
Smart		S	M	L
	4-pt Medium	✓	✓	✓
Nomad				
	4-pt Medium	✓	✓	✓
Nova				
	2-pt Small	✓		
	2-pt Medium	✓	✓	
	2-pt Large		✓	✓
	4-pt Medium		✓	✓
	4-pt Large			✓

Wahl des passenden Hebetuchs

Die Wahl des Hebetuchs hängt zum Teil vom Gewicht sowie von Körperform bzw. Größe des Benutzers ab.

Die Tragfähigkeit (SWL, Safe Working Load) beträgt 300kg.

Fehlersuche und -behebung

Symptom	Mögliche Ursache / Maßnahme
Das Hebetuch passt dem Benutzer nicht.	Falsche Hebetuchgröße. Probieren Sie eine andere Größe aus
	Das Hebetuch ist zu klein, wenn die Oberschenkelauflagen nicht bis zur Mitte um die Schenkelinnenseiten herum reichen und die Aufhängung sich zu nah am Gesicht des Benutzers befindet. Probieren Sie eine andere Größe aus.
	Das Hebetuch ist nicht richtig positioniert. Führen Sie das Hebetuch beim Anpassen tief genug in den Rückenbereich ein
Nicht alle Schlaufen werden gleichzeitig angehoben	Wenn die Schlaufen nicht gleichmäßig angehoben werden, bedeutet dies, dass sich das Hebetuch im Rückenbereich stärker anhebt und der Benutzer dadurch nach unten in die Öffnung des Hebetuchs rutscht. Stellen Sie sicher, dass die Oberschenkelauflagen ordnungsgemäß um die Oberschenkel herum angelegt sind

Nederlandse handleiding

Inhoud

Algemeen	64
Test en garantie.....	64
Veiligheidsmaatregelen	65
Inspectie.....	65
Periodieke inspectie	65
Beschrijving	66
Etac Molift RgoSling Comfort HighBack.....	66
Verzorging/wassen	66
Sling aanbrengen	68
Tillen	69
In zitpositie laten zakken.....	69
Sling verstellen en controlepunten	70
Sling verwijderen.....	71
Combinatielijst	72
Handleiding sling.....	72
Problemen oplossen	73

Test en garantie

CE dit product heeft de CE-markering.

Etac Molift-slings zijn getest door erkende testinstituten en voldoen aan de normen zoals vastgelegd in de Richtlijn Medische Hulpmiddelen voor producten van klasse 1 MDR (EU) 2017/745. De slings voldoen aan de specificaties van de EN ISO 10535 norm.

Garantie: Twee jaar op materiaal- en productiefouten bij correct gebruik.

Kijk op www.molift.com voor meer informatie over het Molift-assortiment slings van Etac.

Algemeen

Bedankt dat u voor een Molift-sling van Etac hebt gekozen.

Lees deze handleiding aandachtig door om schade bij het hanteren en gebruik van het product te voorkomen.

In deze handleiding is de gebruiker de persoon die wordt getild. De assistent is de persoon die de sling bedient.



Dit symbool wordt samen met tekst in de handleiding weergegeven. Het wijst erop dat voorzichtigheid is geboden in verband met de veiligheid van de gebruiker of de assistent.

Etac verbetert zijn producten voortdurend. Daarom behouden wij ons het recht voor om de producten zonder kennisgeving vooraf aan te passen.



Ga naar www.molift.com voor meer informatie, advies en eventuele documentatie-updates.

Wij zijn niet verantwoordelijk voor drukfouten of onvolledigheden in de tekst.

Veiligheidsmaatregelen



Voorafgaand aan het gebruik dient u de handleidingen van de lift en de sling aandachtig door te lezen om letsel bij het gebruiken van het product te voorkomen.

Het is belangrijk dat de sling eerst wordt getest met de individuele gebruiker en voor de bedoelde tilsituatie. Beoordeel of er een of meerdere assistenten nodig zijn.

Plan de tilhandeling vooraf zodat ze zo veilig en probleemloos mogelijk verloopt. Vergeet niet om ergonomisch te werken.

Evalueer de risico's en maak notities. Als verzorger bent u verantwoordelijk voor de veiligheid van de gebruiker.



Til een gebruiker nooit hoger dan noodzakelijk is om de transfer te kunnen uitvoeren. Laat de gebruiker tijdens het tillen nooit alleen achter.



Controleer altijd of de gebruiker geschikt is voor de betreffende sling.

- Of het model, de maat en het materiaal geschikt zijn.
- Of de sling geschikt is voor de tilmanoeuvre/ ophanging.
- Controleer voordat de gebruiker wordt getild, altijd of de bandlussen correct aan de haken van de ophanging zijn bevestigd.
- Zorg dat alle wielen van de rolstoel of het bed vergrendeld zijn als dit voor het transferproces noodzakelijk is.

Inspectie

De sling moet regelmatig worden geïnspecteerd, bij voorkeur voor elke tilmanoeuvre, maar met name ook nadat hij is gewassen.

- Controleer of naden, stof, banden en lussen geen slijtage of beschadigingen vertonen.



Gebruik nooit een versleten of beschadigde sling omdat dit tot letsel bij de patiënt kan leiden. Vernietig en dank beschadigde en oude slings af.



Bewaar de sling niet op een plek waar hij aan direct zonlicht wordt blootgesteld.

Periodieke inspectie

Om de 6 maanden dient er een periodieke inspec-

tie te worden uitgevoerd. Het kan noodzakelijk zijn om dit interval te verkorten als de sling met een hoge frequentie wordt gebruikt of gewassen. Zie het periodieke inspectieformulier op www.molift.com

EN

SV

NO

DA

FI

DE

NL

FR

IT

ES

Beschrijving

Etac Molift heeft een breed assortiment slings voor verschillende transfertypes. De Etac Molift RgoSling is ontworpen voor een gelijkmatige last/gewicht-ratio, voor een optimaal gebruikscomfort.

De bovenste hangbanden van de sling kunnen worden verschoven, zodat de sling tijdens het verplaatsen volledig in balans kan blijven. De gebruiker ervaart hierdoor een hoge mate van comfort en een prettige ervaring bij het optillen.

Er is een geleiderhandgreep om de gebruiker in de juiste zitpositie te manoeuvreren. Die wordt alleen gebruikt in de tilmodus.

De Etac Molift RgoSling is ontwikkeld voor gebruik met een 4-punts slingstang, maar kan ook met een 2-punts slingstang worden gebruikt. Raadpleeg de combinatielijst om de juiste sling en slingstang te combineren.

De Molift RgoSling Comfort Highback is leverbaar in de maten S-L, uitgevoerd in polyester mesh.

Molift RgoSling Comfort HighBack

Dit is een niet-gevoerde sling die zich naar het lichaam vormt. De sling blijft na het optillen en verplaatsen onder de gebruiker. Het product is gemaakt van een polyester meshmateriaal dat vocht- en warmtedoorlatend is. De sling kan alleen worden aangebracht terwijl de gebruiker ligt. De armen worden in de sling geplaatst en de sling biedt een comfortabele zitpositie met volledige ondersteuning van hoofd en lichaam.

Het product heeft bij normaal gebruik een levensduur van 1 tot 5 jaar. De levensduur van het product varieert naar gelang het gebruik, de materialen, belasting en hoe vaak het wordt gewassen.

- A1. Productlabel
- A2. (01) EAN-code
xxxxxxxxxxxxxx
(21) Serienummer
xxxxxxx
- A3. QR-code
- A4. Label: Periodieke inspectie
- A5. Label: Gebruikersnaam
- A6. Bandlussen boven
- A7. Geleiderhandgreep, zij
- A8. Bandlussen onder
- A9. Symbool: Lees de handleiding voor het gebruik
- A10. Symbool: Max. gewicht gebruiker
- A11. Symbool: Deze zijde van het product boven en naar buiten plaatsen
- A12. Symbool: Uitvouwen voor meer informatie

Verzorging/wassen

Lees de aanwijzingen over de verzorging van het product.

1. In water wasbare slings kunnen worden gewassen op een temperatuur van 60 tot 85 °C.



Door op een hogere temperatuur te wassen, zal het materiaal eerder verslijten.

2. Wasdroger op max. 45 °C.
Autoclaveerbaar op 85 graden gedurende 30 minuten
3. Niet chemisch reinigen
4. Niet bleken.
5. Niet strijken.

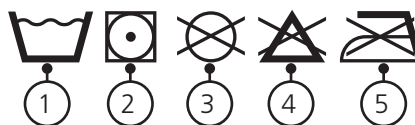

Symbolen:



Fabrikant



Productie-datum JJJJ-MM-DD
(jaar/maand/tag)



CE-markering



Zie de bedienings-handleiding



Deze kant boven, dit is de buitenkant



Max. gewicht gebruiker (veilige belasting):



Medisch hulpmiddel

EN
SV
NO
DA
FI
DE
NL
FR
IT
ES

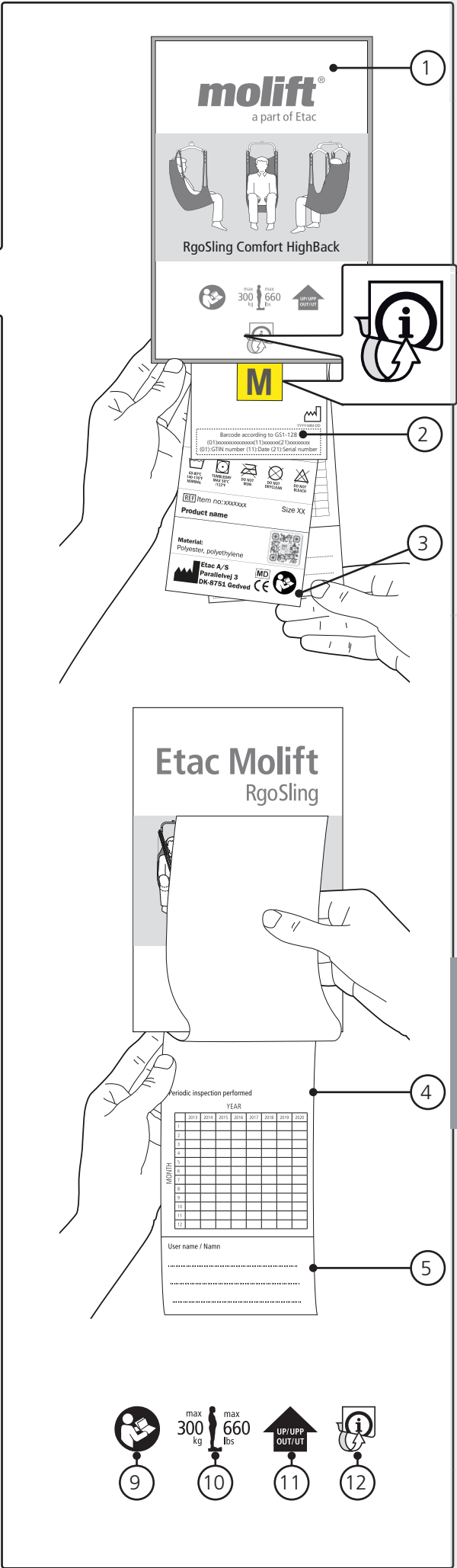
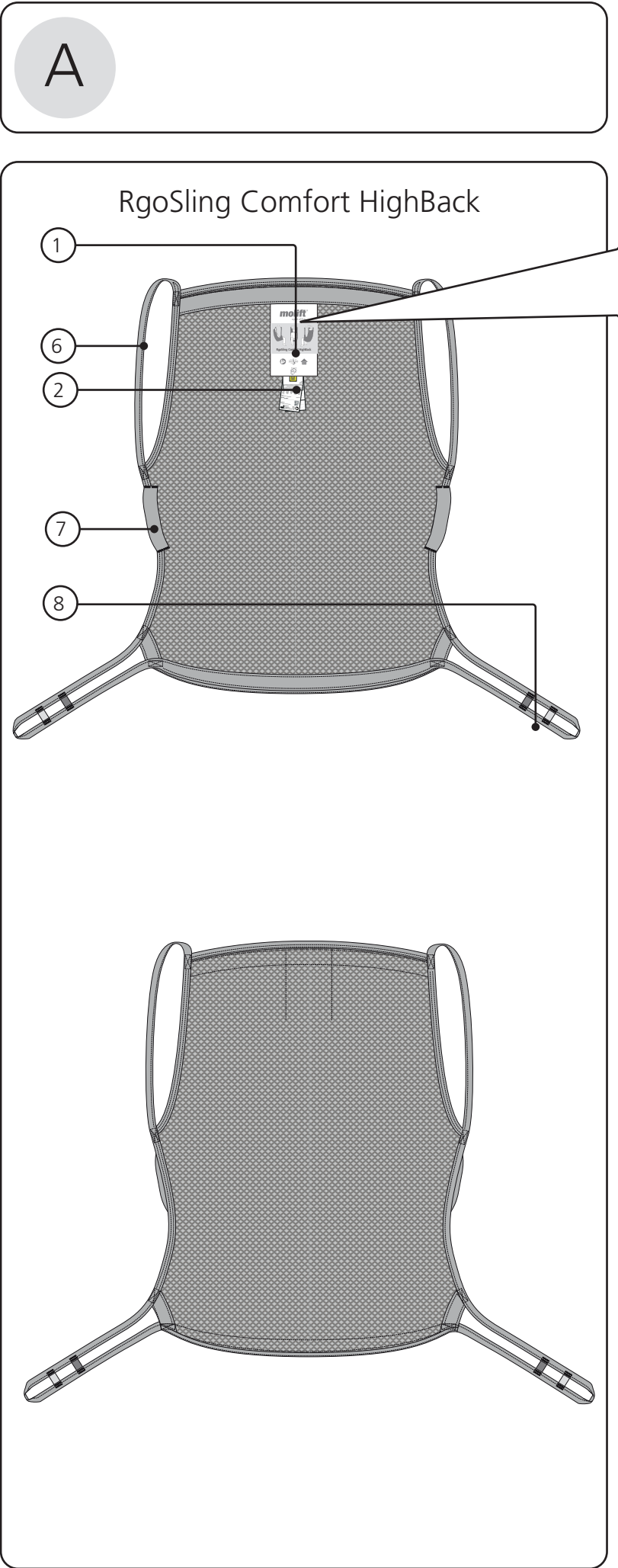

B

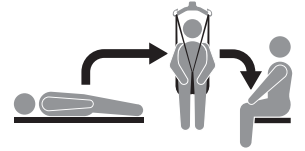

Sling aanbrenge

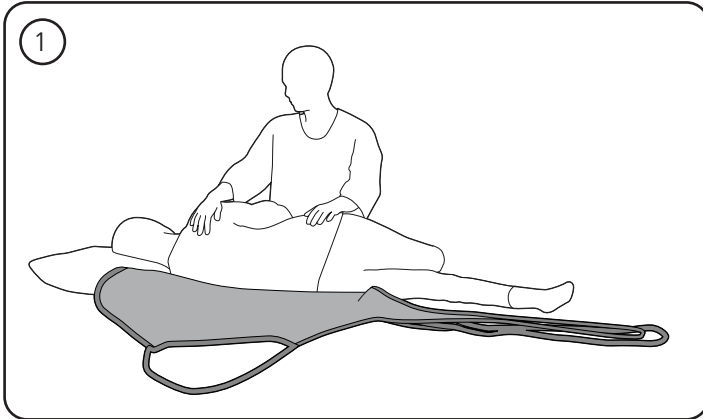

B1. Draai de gebruiker naar u toe tot hij/zij stabiel op zijn/haar zij ligt. Vouw de sling in het midden en plaats hem achter de rug van de gebruiker.

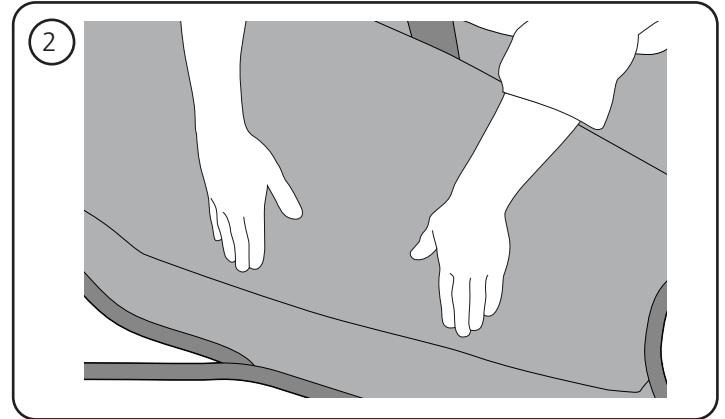

B2. Draai de gebruiker vervolgens op de andere zijde en trek de sling naar voren. Zorg dat de gebruiker in het midden van de sling ligt. Als het bed een rugsteun heeft, kan die worden gebruikt. Draai de gebruiker altijd voorzichtig om. Zorg ervoor dat hij/zij niet omrolt en uit het bed valt.

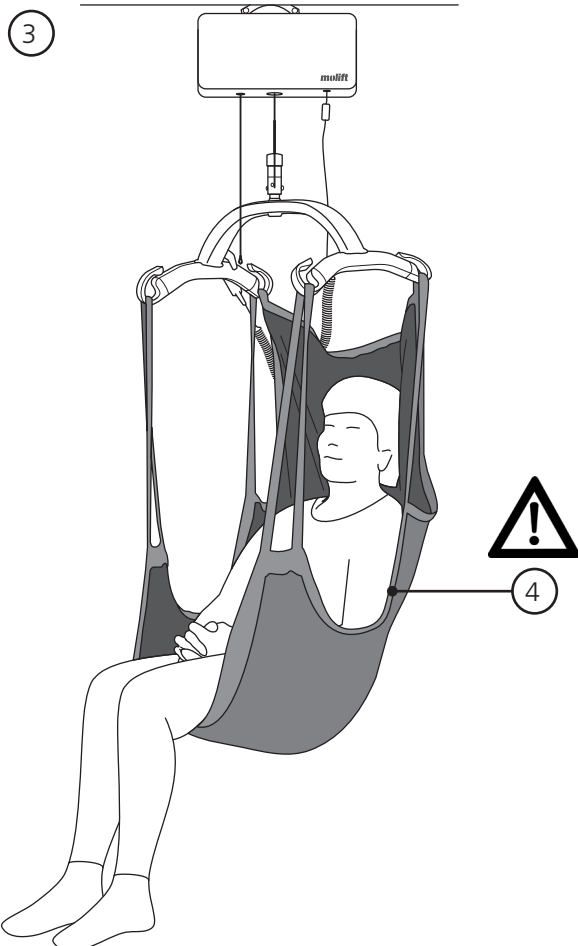

B3. De beunsteunen niet kruisen. Heeft de gebruiker een instabiele romp of is hij/zij spastisch (onwillekeurige spiercontracties) dan kan hij/zij vooruit uit de sling vallen. In dat geval raden we aan de gebruiker zo ver mogelijk naar achteren te laten liggen en de binnenste aansluitpunten op de onderste tilbanden te gebruiken.

B4. Er is een geleiderhandgreep om de gebruiker in de juiste zitpositie te manoeuvreren. Die wordt alleen gebruikt in de tilmodus. Dit is geen bandlus voor het tillen.

Tillen

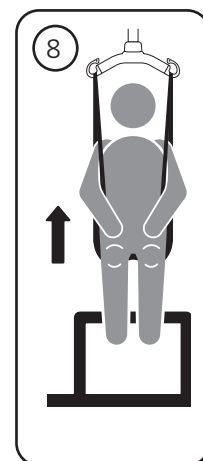
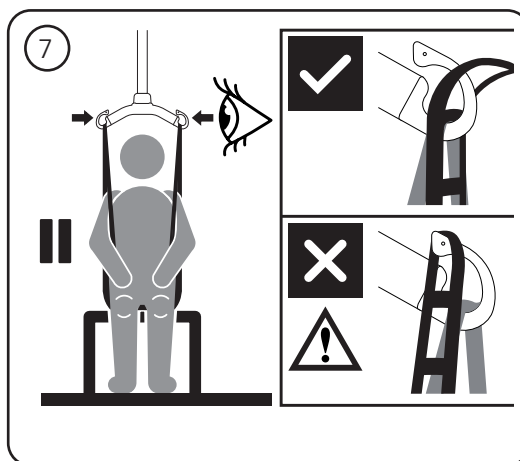
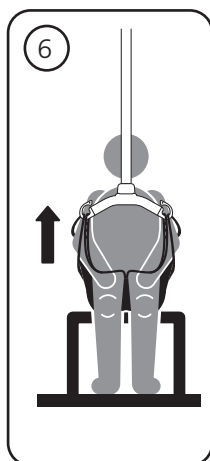
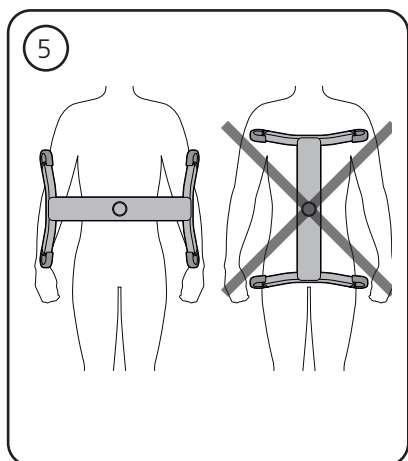

- B5. De slingstang moet altijd tegenover de gebruiker worden geplaatst, zodat de gebruiker niet uit de sling kan glijden.
- B6. Bevestig de sling aan de haken van de slingstang.
- B7. Haal omhoog tot de lussen strak staan, maar til de gebruiker nog niet op. Controleer of

- de gebruiker goed in de sling is geplaatst en of de bandlussen op de juiste wijze aan de slingstanghaken zijn bevestigd.
- B8. Til de gebruiker niet hoger dan noodzakelijk is. Vergeet niet dat de wielen op een mobiele lift NIET vergrendeld moeten zijn.

In zitpositie laten zakken

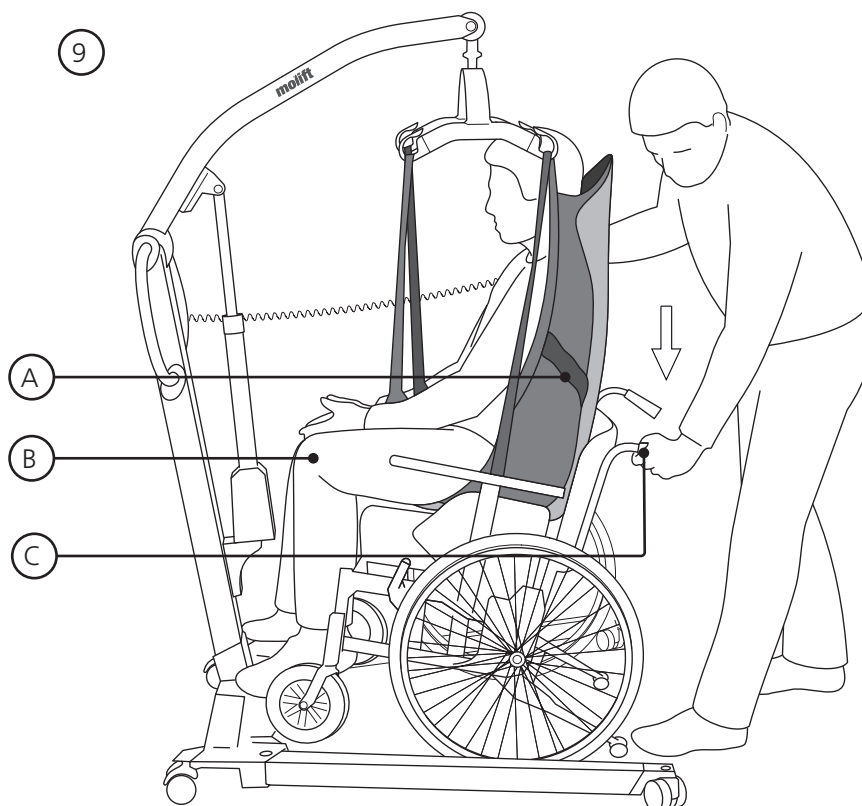

- B9. Bij het verplaatsen van de gebruiker naar een zittende positie, kunt u hem/haar met de volgende technieken zo ver mogelijk naar achteren plaatsen::

- A. Plaats de gebruiker met behulp van de geleiderhandgreep.
- B. Duw voorzichtig tegen de knieën van de gebruiker.
- C. Kantel de zitting naar achteren.

C

Sling verstellen en controlepunten

RgoSling Comfort HighBack

- C1. Zorg dat de ophanging niet het gezicht van de gebruiker raakt.
- C2. Zorg dat de hoofdsteun niet te laag is. De sling moet boven het hoofd van de gebruiker uitkomen.
- C3. Zorg dat de sling goed onder de dijen is geplaatst.
- C4. De onderste bandlussen niet kruisen.

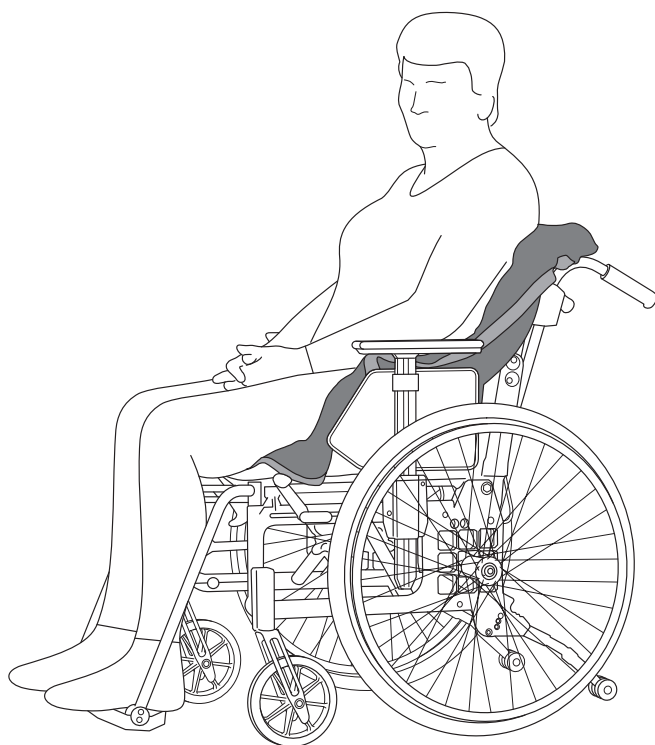
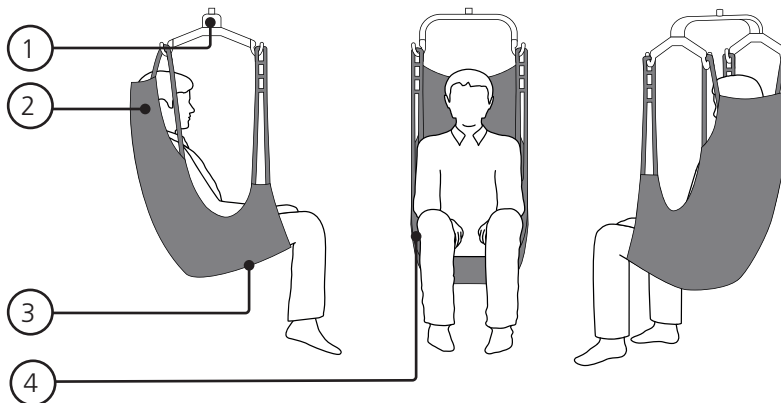

- C5. De sling moet na de transfer onder de gebruiker blijven.



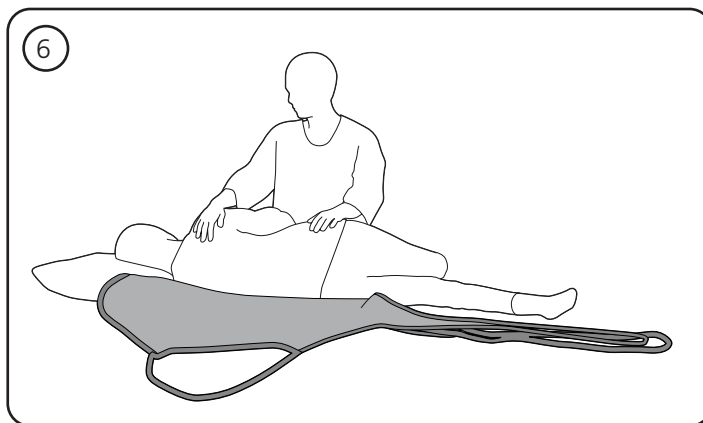





Sling verwijderen

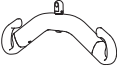
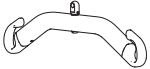
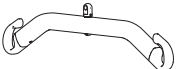

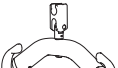
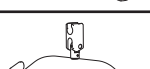
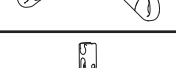

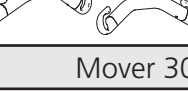

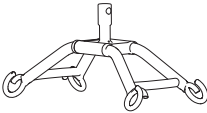
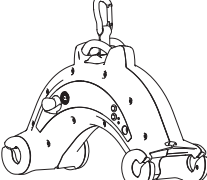

C6. Verwijder de lussen van de ophanging. Draai de gebruiker naar u toe tot hij/zij stabiel op zijn/haar zij ligt. Vouw de sling in het midden en plaats hem achter de rug van de gebruiker.

Draai de gebruiker vervolgens op de andere zij en trek de sling weg. Draai de gebruiker altijd voorzichtig om. Zorg ervoor dat hij/zij niet doorrolt en uit het bed valt.

Combinatielijst

Ophanging		RgoSling Comfort HighBack		
		S	M	L
Mover 180				
	2-pt Small	✓		
	2-pt Medium	✓	✓	
	2-pt Large		✓	✓
	4-pt Medium	✓	✓	✓
	4-pt Large		✓	✓
Mover 205				
	2-pt Small	✓		
	2-pt Medium	✓	✓	
	2-pt Large		✓	✓
	4-pt Medium	✓	✓	✓
	4-pt Large		✓	✓
Mover 300				
	4-pt Medium	✓	✓	✓
	4-pt Large		✓	✓
Partner 255				
	4-pt Medium	✓	✓	✓
	4-pt Large		✓	✓

Ophanging		RgoSling Comfort HighBack		
Smart		S	M	L
	4-pt Medium	✓	✓	✓
Nomad				
	4-pt Medium	✓	✓	✓
Nova				
	2-pt Small	✓		
	2-pt Medium	✓	✓	
	2-pt Large		✓	✓
	4-pt Medium		✓	✓
	4-pt Large			✓

Handleiding sling

De te selecteren maat hangt deels af van het gewicht, functie en lichaamsomtrek/omvang van de gebruiker. De veilige werkbelasting (SWL) is 300 kg.

Problemen oplossen

Probleem	Mogelijke oorzaak/oplossing
De gebruiker past niet goed in de sling.	Verkeerde slingmaat. Probeer een andere maat.
	De sling is te klein als de beensteunen niet tot halverwege de binnenkant van de dijnen reiken en de ophanging te dicht bij het gezicht van de gebruiker is. Probeer een andere maat.
	De sling is niet goed aangebracht. Trek de sling bij het aanbrengen bij de rug goed naar beneden.
Het gewicht wordt niet gelijktijdig over alle banden verdeeld.	Als de banden van de sling niet even lang zijn, betekent dit dat de sling aan de achterzijde omhoog kan schuiven en de gebruiker in de opening in de sling kan zakken. Zorg dat de beensteunen goed op de dijnen zijn geplaatst.

EN

SV

NO

DA

FI

DE

NL

FR

IT

ES

Manuel français

Table des matières

Généralités.....	74
Test et garantie	74
Consignes de sécurité.....	75
Inspection.....	75
Inspection périodique	75
Description.....	76
Etac Molift RgoSling Comfort HighBack.....	76
Entretien/nettoyage	76
Application du harnais.....	77
Levage	78
Installation en position assise	78
Réglage du harnais et points de vérification	79
Retrait du harnais	80
Liste des associations.....	82
Guide des harnais.....	82
Dépannage	83

Test et garantie

CE Ce produit est marqué CE.

Les harnais Etac Molift sont testés par des organismes agréés et respectent les normes définies dans la Directive sur les dispositifs médicaux de classe 1 MDR (EU) 2017/745. Les harnais sont conformes aux exigences spécifiées dans la norme EN ISO 10535.

Garantie : deux ans pour tout défaut matériel ou de fabrication en cas d'utilisation correcte.

Pour en savoir plus sur la gamme de harnais et de lève-personnes Etac Molift, consultez le site www.molift.com

Généralités

Merci d'avoir choisi un harnais Molift Etac.

Lisez attentivement ce manuel afin d'éviter tout dommage lorsque vous manipulez et utilisez ce produit.

Dans ce manuel, l'« utilisateur » désigne la personne soulevée. L'« assistant » est la personne actionnant le harnais.



Dans ce manuel, ce symbole s'accompagne d'un texte. Il attire l'attention sur les risques pour la sécurité de l'utilisateur ou de l'assistant.

Etac améliore en permanence ses produits. Nous nous réservons donc le droit de les modifier sans préavis.



Rendez-vous sur www.molift.com pour obtenir des informations, des conseils et les mises à jour des documents.

Nous ne saurions être tenus pour responsables des erreurs d'impression ou des omissions.

Consignes de sécurité



Lisez attentivement le manuel du harnais et du lève-personne avant d'utiliser ces dispositifs afin d'éviter toute blessure lors de la manipulation et de l'utilisation de ces produits.

Il est important que le harnais soit testé avec chaque utilisateur et pour le levage prévu. Décidez du nombre d'assistants nécessaires.

Planifiez l'opération de levage en avance afin de garantir une procédure aussi sûre et en douceur que possible. Pensez à adopter une position de travail ergonomique.

Évaluez les risques et prenez des notes. En tant que soignant, vous êtes responsable de la sécurité de l'utilisateur.



Ne soulevez jamais l'utilisateur plus haut que nécessaire pour procéder au levage. Ne laissez jamais un utilisateur sans surveillance au cours d'un levage.



Vérifiez toujours que l'utilisateur présente la capacité nécessaire pour le harnais choisi.that the user has the required ability for the sling in question

- Le modèle, la taille et le matériel doivent être adaptés.
- Le harnais doit convenir au lève-personne ou à la suspension utilisé.
- Il convient de vérifier que les boucles des sangles sont correctement fixées sur les crochets de la suspension avant de lever l'utilisateur.
- Assurez-vous que les roues du fauteuil roulant, du lit ou de la couchette sont bloquées lorsque c'est nécessaire pendant la procédure de transfert.

Inspection

Inspectez régulièrement le harnais, de préférence avant chaque opération de levage et en particulier après le nettoyage.

- Vérifiez l'absence d'usure ou de dommages au niveau des coutures, du tissu, des sangles et des boucles.



N'utilisez jamais de harnais défectueux ou endommagé qui risquerait de se déchirer ou de provoquer des blessures. Détruisez et jetez les harnais endommagés ou usés.



Ne rangez pas le harnais à la lumière

directe du soleil.

Inspection périodique

Une inspection périodique doit être réalisée au moins tous les 6 mois. Des inspections plus régulières peuvent s'avérer nécessaires si le harnais est utilisé ou nettoyé plus souvent que la normale. Consultez le formulaire des inspections périodiques sur le site www.molift.com.

EN

SV

NO

DA

FI

DE

NL

FR

IT

ES

Description

Etac Molift propose une grande variété de harnais convenant à divers types de transfert. L'Etac Molift RgoSling a été conçu pour offrir un rapport poids/charge uniforme afin de le rendre le plus confortable possible.

Les sangles de suspension supérieures du harnais peuvent coulisser afin que le harnais trouve un équilibre stable pendant la totalité du transfert. L'utilisateur bénéficie ainsi d'un grand confort et d'un levage agréable.

Une poignée guide permet d'installer les utilisateurs dans la position assise qui convient, uniquement en mode levage.

La gamme de harnais Etac Molift RgoSling a été développée pour être associée à une barre de harnais à 4 points mais le harnais fonctionne également avec une barre à 2 points. Reportez-vous à la liste des associations adéquates de harnais et de barres.

Le Molift RgoSling Comfort HighBack est disponible en tailles S – L, en polyester maillé.

Molift RgoSling Comfort HighBack

Ce harnais non matelassé s'adapte à la forme du corps. Il est destiné à rester sous l'utilisateur après le levage et à la fin du transfert. Il est composé d'un matériau maillé en polyester qui laisse passer l'humidité et la chaleur corporelles. Le harnais ne peut être appliqué que lorsque l'utilisateur est couché. Les bras sont placés dans le harnais et celui-ci procure une position assise confortable avec un soutien complet du corps et de la tête.

Ce produit présente une durée de vie de 1 à 5 ans dans des conditions normales d'utilisation. Sa durée de vie dépend de la fréquence d'utilisation, des matières, des charges et de la fréquence de nettoyage.

- A1. Étiquette du produit
- A2. (01) Code EAN
xxxxxxxxxxxxxxxxxx
- (21) Numéro de série
xxxxxxx
- A3. Code QR
- A4. Étiquette : Inspection périodique
- A5. Étiquette : Nom de l'utilisateur
- A6. Boucles de sangles supérieures
- A7. Poignée guide, côté
- A8. Boucles de sangle inférieure
- A9. Symbole : Lisez le manuel avant utilisation
- A10. Symbole : Poids max. de l'utilisateur
- A11. Symbole : Ce côté du produit est orienté vers le haut et vers l'extérieur
- A12. Symbole : Encart pour plus d'informations

Entretien/nettoyage

Lisez les consignes d'entretien disponibles sur le produit.

1. Les harnais lavables à l'eau peuvent être nettoyés à des températures comprises entre 60 et 85 °C.
2. Lavée à des températures élevées, la matière s'use plus vite.
3. Séchage en tambour, max. 45 °C. Peut être autoclavé à 85 degrés pendant 30 minutes
4. Ne pas laver à sec.
5. Ne pas passer à la javel.
6. Ne pas repasser.

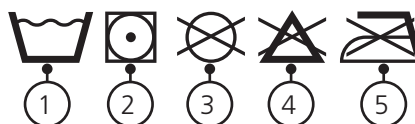

Symboles:



Fabricant



Date de fabrication.
AAAA-MM-DD
(année/mois/jour)



Marquage CE



Consultez le manuel
d'utilisation



Vers le haut,
côté extérieur



Poids max. de
l'utilisateur :



Dispositif médical

A

RgoSling Comfort HighBack

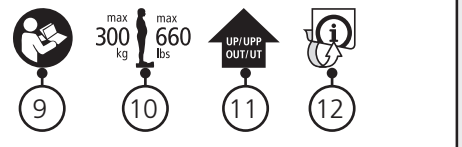
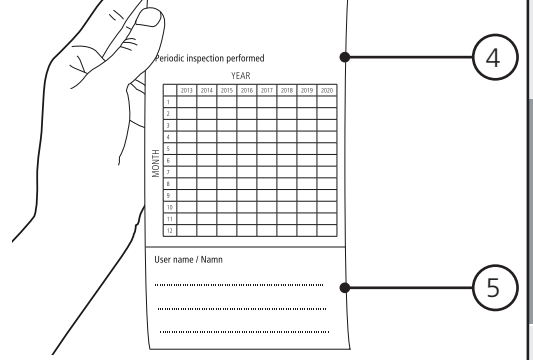
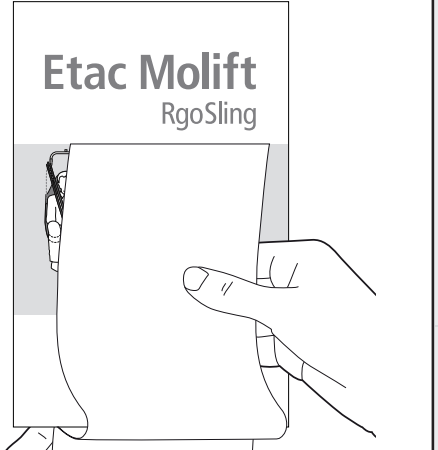
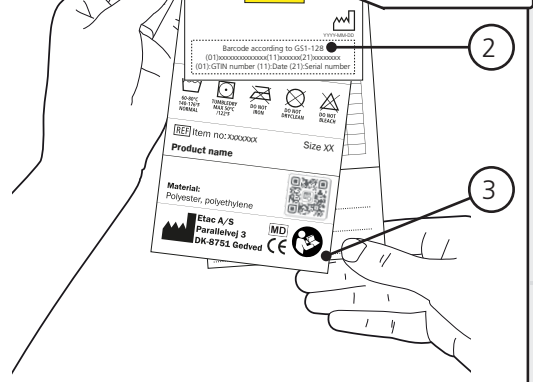
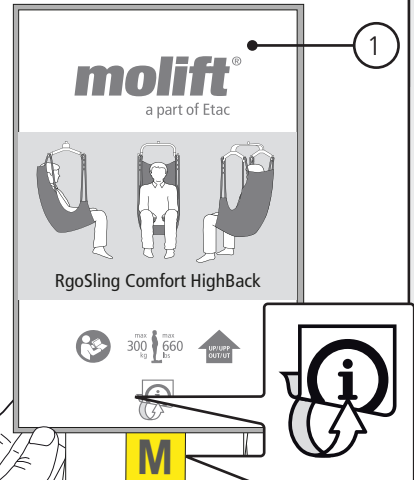
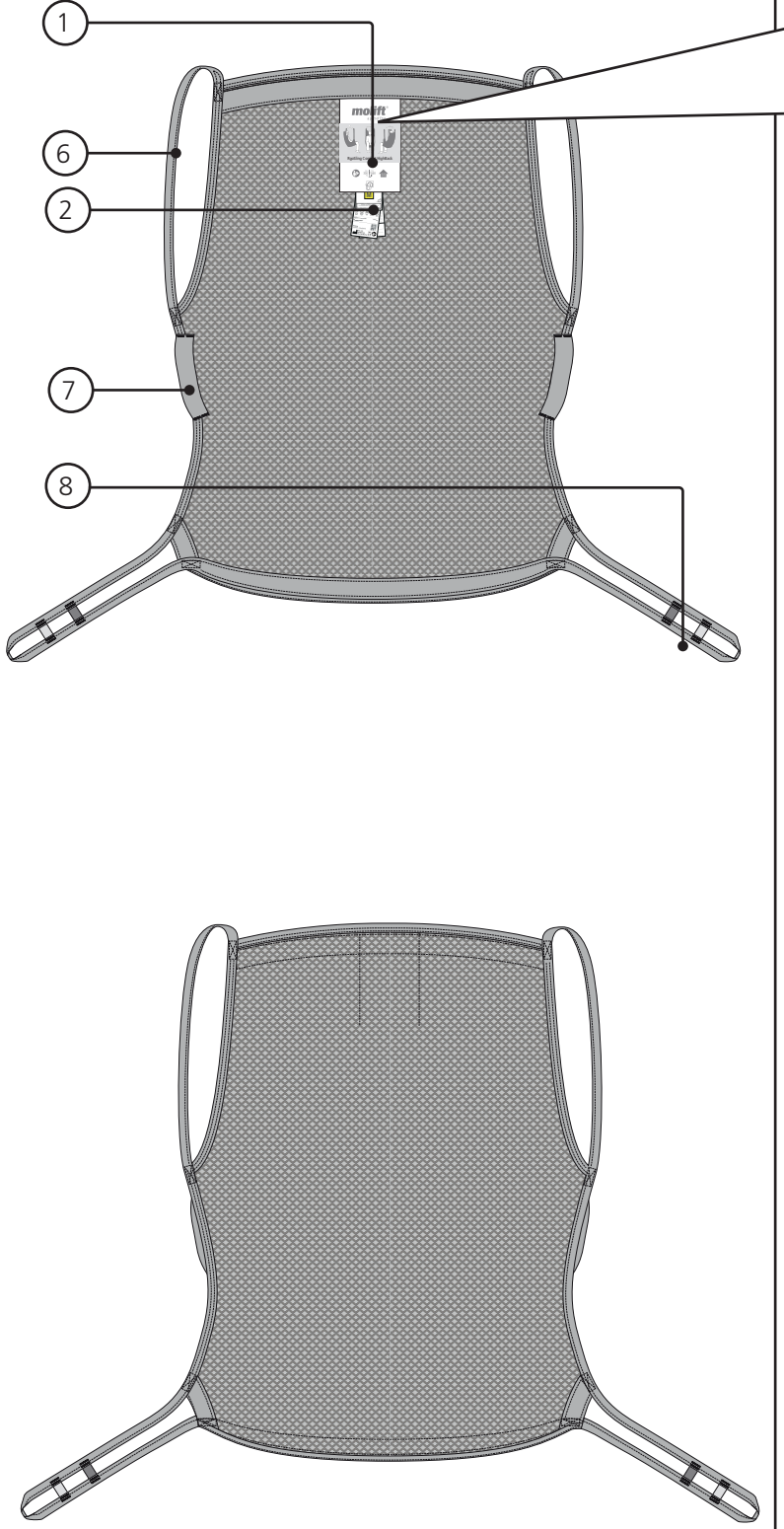

B

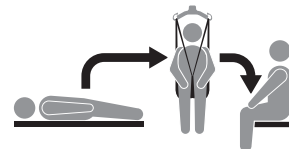

Application du harnais

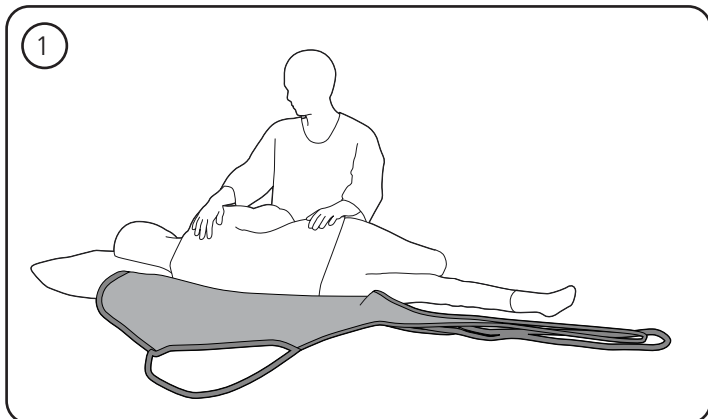

B1. Tournez l'utilisateur vers vous jusqu'à ce qu'il repose sur le côté en toute sécurité. Repliez le harnais au milieu et placez-le dans le dos de l'utilisateur.

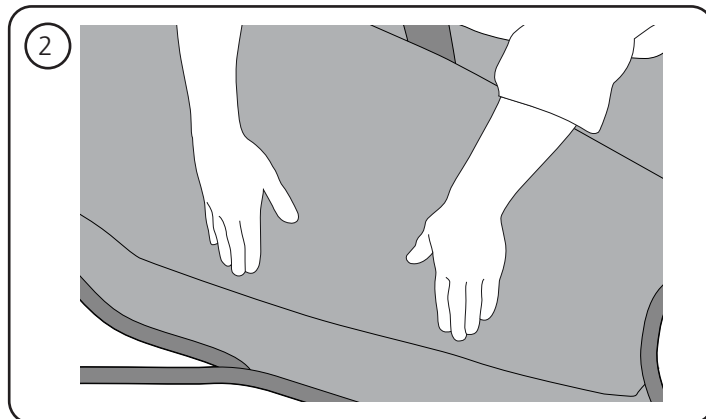

B2. Retournez l'utilisateur de l'autre côté et tirez le harnais vers l'avant. Vérifiez que l'utilisateur est bien placé au milieu du harnais. Si le lit est équipé d'un dossier, ce dernier peut être utilisé. Soyez vigilant lorsque vous remplacez l'utilisateur de l'autre côté. Assurez-vous que l'utilisateur ne bascule pas et ne roule pas du lit.

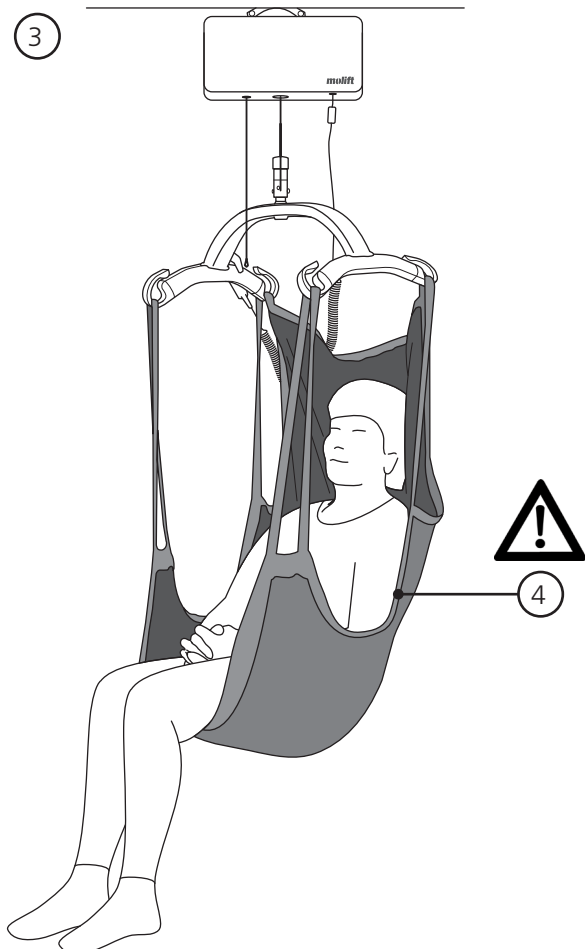

B3. Ne croisez pas le support de jambes. Si l'utilisateur présente une instabilité du torse ou s'il est spastique (contractions musculaires involontaires), il risque de tomber la tête la première du harnais. Dans ce cas, nous vous recommandons de réduire l'inclinaison au maximum en utilisant les points de raccordement internes sur les sangles de levage inférieures.

B4. Une poignée guide permet d'installer les utilisateurs dans la position assise qui convient, uniquement en mode levage. Il ne s'agit pas d'une boucle de sangle pour le levage.

Levage

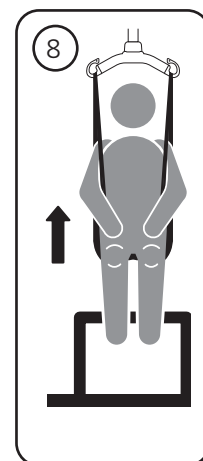
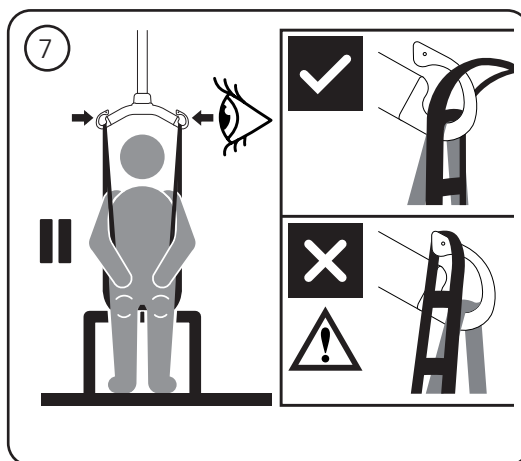
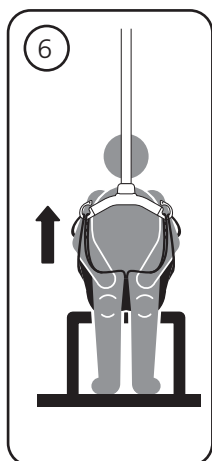
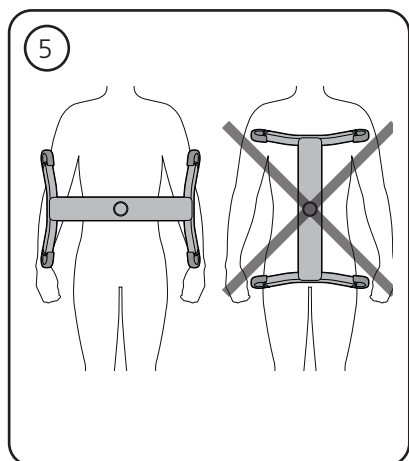

- B5. La barre de harnais doit toujours être positionnée dans la largeur de l'utilisateur afin d'éviter qu'il ne glisse accidentellement du harnais.
- B6. Accrochez le harnais aux crochets de la barre.
- B7. Étirez les sangles du harnais sans soulever l'utilisateur. Vérifiez que le harnais soutient correctement l'utilisateur et que les boucles des

sangles sont correctement fixées aux crochets de la barre.

- B8. Ne soulevez jamais l'utilisateur plus que nécessaire. Rappelez-vous que les roues du lève-personne mobile NE doivent PAS être bloquées.

Installation en position assise

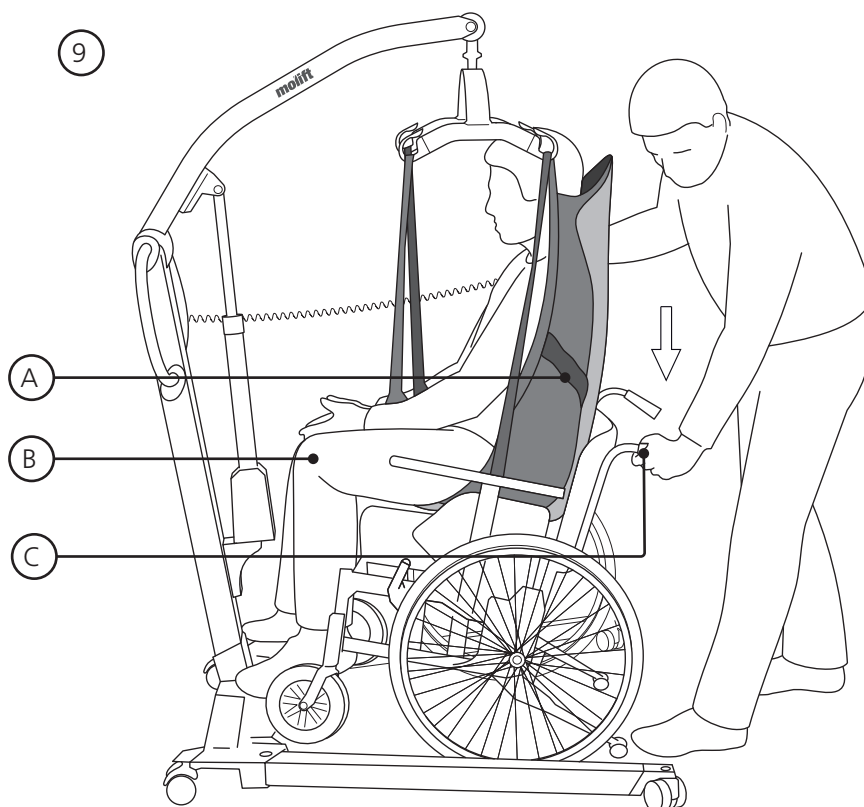

- B9. Lors du transfert de l'utilisateur en position assise, les techniques suivantes peuvent être utilisées pour faire descendre l'utilisateur en lui maintenant le dos le plus près possible du fauteuil :

- A. Installez l'utilisateur à l'aide de la poignée de commande
- B. Appuyez doucement sur les genoux de l'utilisateur
- C. Inclinez le siège vers l'arrière

C

Réglage du harnais et points de vérification

RgoSling Comfort HighBack

- C1. Vérifiez que la suspension se trouve loin du visage de l'utilisateur
- C2. Assurez-vous que le repose-tête n'est pas trop bas. Le harnais doit être placé plus haut que la tête de l'utilisateur.
- C3. Vérifiez que le harnais est bien placé sous les cuisses.
- C4. Ne croisez pas les boucles de sangles inférieures.

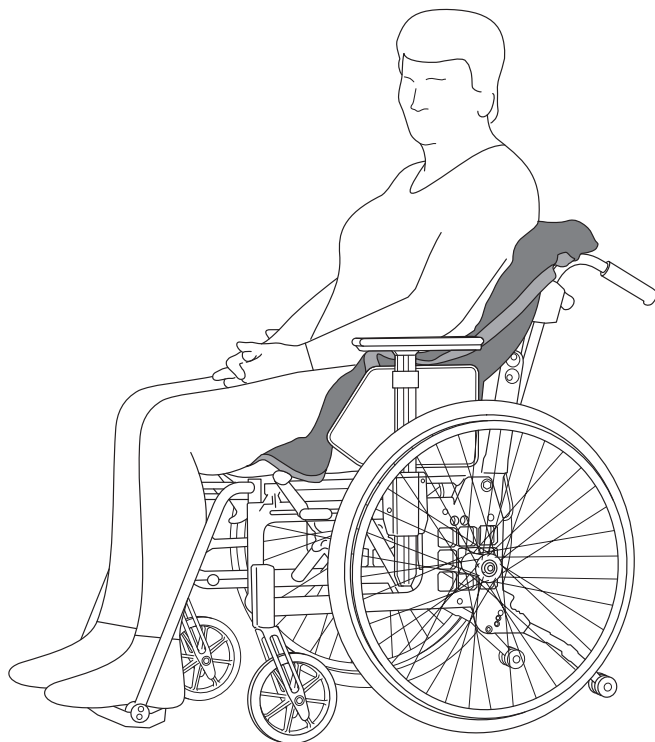
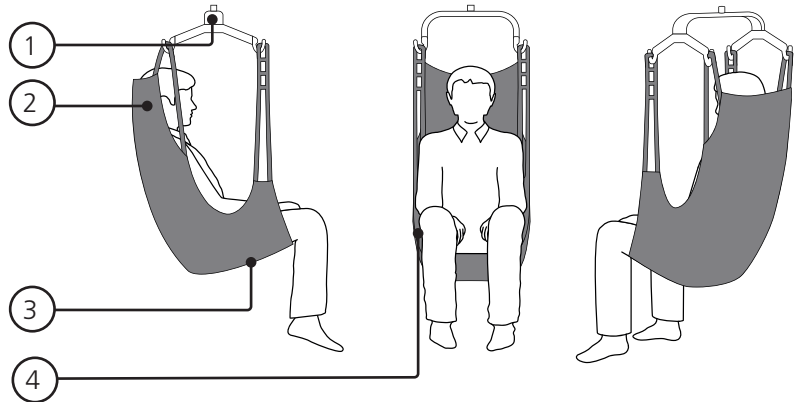

- C5. Le harnais est censé rester sous l'utilisateur après le transfert.

Retrait du harnais

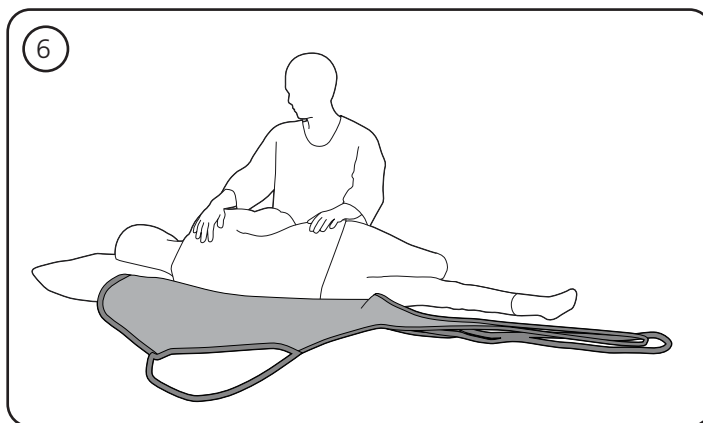









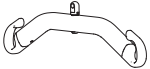
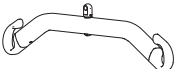

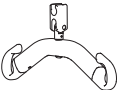
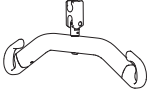
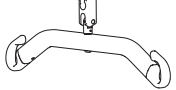



C6. Retirez les boucles de la suspension Tournez l'utilisateur vers vous jusqu'à ce qu'il repose sur le côté en toute sécurité. Repliez le harnais au milieu et placez-le dans le dos de l'utilisateur. Retournez l'utilisateur de l'autre côté et retirez

le harnais. Soyez vigilant lorsque vous replacez l'utilisateur de l'autre côté.

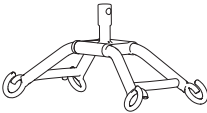
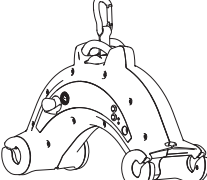
Veillez à ce qu'il ne roule pas et ne tombe pas du lit.

Liste des associations

Suspension		RgoSling Comfort HighBack		
		S	M	L
Mover 180				
	2-pt Small	✓		
	2-pt Medium	✓	✓	
	2-pt Large		✓	✓
	4-pt Medium	✓	✓	✓
	4-pt Large		✓	✓
Mover 205				
	2-pt Small	✓		
	2-pt Medium	✓	✓	
	2-pt Large		✓	✓
	4-pt Medium	✓	✓	✓
	4-pt Large		✓	✓
Mover 300				
	4-pt Medium	✓	✓	✓
	4-pt Large		✓	✓
Partner 255				
	4-pt Medium	✓	✓	✓
	4-pt Large		✓	✓

Suspension		RgoSling Comfort HighBack		
Smart		S	M	L
	4-pt Medium	✓	✓	✓
Nomad				
	4-pt Medium	✓	✓	✓
Nova				
	2-pt Small	✓		
	2-pt Medium	✓	✓	
	2-pt Large		✓	✓
	4-pt Medium		✓	✓
	4-pt Large			✓

Guide des harnais

La taille dépend en partie du poids de l'utilisateur, de l'utilisation et de la circonférence corporelle de l'utilisateur. La SWL (charge maximale d'utilisation) est de 300 kg.

Dépannage

Problème	Cause/mesure possible
Le harnais ne convient pas à l'utilisateur.	Taille de harnais incorrecte. Essayez une autre taille.
	Le harnais est trop petit lorsque les supports de jambes n'atteignent pas la moitié de la cuisse intérieure et lorsque la suspension est trop proche du visage de l'utilisateur. Essayez une autre taille.
	Le harnais n'est pas correctement installé. Placez le harnais assez bas dans le dos lors de l'ajustement.
Toutes les sangles ne se soulèvent pas en même temps.	Si les sangles du harnais se soulèvent de façon irrégulière, cela signifie que le harnais peut glisser dans le dos, ce qui risque de faire glisser l'utilisateur dans l'ouverture. Vérifiez que les supports de jambes sont correctement positionnés sur les cuisses.

EN

SV

NO

DA

FI

DE

NL

FR

IT

ES

Manuale italiano

Indice

Cenni generali	84
Test e garanzia	84
Precauzioni di sicurezza	85
Ispezione	85
Ispezione periodica	85
Descrizione	86
Etac Molift RgoSling Comfort HighBack	86
Pulizia/lavaggio.....	86
Applicazione dell'imbragatura in posizione sdraiata.....	88
Sollevamento	89
Transferimento	89
Regolazione dell'imbragatura e punti di controllo	90
Rimozione dell'imbragatura	91
Elenco di possibili combinazioni	92
Guida dell'imbragatura	92
Risoluzione dei problemi.....	93

Descrizione

Grazie per aver scelto un'imbragatura della gamma Molift di Etac.

Per evitare danni durante la manipolazione e l'utilizzo del prodotto è necessario leggere attentamente questo manuale.

In questo manuale, il termine "utente" è riferito alla persona che viene sollevata.

L'assistente è invece la persona che maneggia l'imbragatura.



Nel manuale questo simbolo compare unitamente a un testo. Indica la necessità di prestare attenzione nei casi di possibili rischi per l'utente o l'assistente.

Etac si impegna a migliorare continuamente i propri prodotti. Ci riserviamo pertanto il diritto di apportare modifiche ai prodotti senza preavviso.



Per maggiori informazioni, suggerimenti e aggiornamenti relativi alla documentazione, visitare il sito www.molift.com.

Si declina qualsiasi responsabilità per eventuali omissioni o errori di stampa.

Test e garanzia

CE Questo prodotto è munito del marchio CE.

Le imbragature Etac Molift sono testate da istituti accreditati e rispondono agli standard definiti nella Direttiva UE sui dispositivi medici 2017/745 per i prodotti di classe 1 (MDR). L'imbragatura soddisfa i requisiti della norma EN ISO 10535.

Garanzia: due anni per difetti di materiale e fabbricazione, a condizione che il prodotto sia correttamente utilizzato.

Maggiori dettagli sulla gamma di imbragature e dispositivi di sollevamento Etac Molift sono disponibili alla pagina www.molift.com.

Precauzioni di sicurezza

Aspetti da osservare



Per evitare infortuni durante la manipolazione e l'utilizzo del prodotto, prima dell'uso è necessario leggere attentamente il manuale per il dispositivo di sollevamento e l'imbragatura.

È importante che l'imbragatura venga testata per lo specifico utente e per le specifiche condizioni a cui quest'ultimo dovrà essere sollevato. È opportuno valutare se sia necessario più di un assistente.

Pianificare anticipatamente l'operazione di sollevamento per garantire che venga eseguita nel modo più agevole e sicuro possibile. Garantire una posizione ergonomica.

Valutare i rischi e prenderne nota. La sicurezza dell'utente è di responsabilità dell'operatore.



Non sollevare mai un utente più in alto di quanto sia necessario per eseguire l'operazione di sollevamento. Non lasciare mai l'utente solo mentre è sollevato.



Controllare sempre

- che l'utente disponga delle abilità richieste per l'uso dell'imbragatura in questione;
- che il modello, la taglia e il materiale siano idonei;
- che l'imbragatura sia idonea per il dispositivo di sollevamento ovvero per la barra per imbragatura da utilizzare.
- Prima di sollevare l'utente, è importante verificare che i passanti delle cinghie siano correttamente fissati ai ganci della barra per imbragatura.
- Accertarsi che le ruote della sedia a rotelle, del letto o della branda siano all'occorrenza bloccate durante l'operazione di trasferimento.

Ispezione

L'imbragatura deve essere ispezionata regolarmente, se possibile prima di ogni operazione di sollevamento e soprattutto dopo ogni lavaggio. Accertarsi che le cuciture, il tessuto, le cinghie e i passanti non presentino segni di usura.



Per evitare il rischio di rotture o infortuni, non utilizzare mai imbragature difettose o danneggiate. Eliminare le imbragature vecchie e danneggiate.



Non depositare l'imbragatura in un punto direttamente esposto al sole.

Ispezione periodica

Le ispezioni periodiche vanno svolte almeno ogni 6 mesi. Se l'imbragatura è utilizzata o lavata con una frequenza superiore al normale può essere necessario accorciare gli intervalli di ispezione. Consultare il modulo di ispezione periodica disponibile alla pagina www.molift.com.

EN

SV

NO

DA

FI

DE

NL

FR

IT

ES

Descrizione

La gamma Etac Molift offre un'ampia selezione di imbragature per diverse tipologie di trasferimenti. L'imbragatura Molift RgoSling è concepita per distribuire uniformemente il peso e la pressione e massimizzare così il comfort.

Le cinghie di sospensione superiori dell'imbragatura possono essere fatte scorrere per mantenere l'utente in equilibrio durante l'intera operazione di trasferimento. Ciò garantisce il massimo comfort per l'utente durante il sollevamento.

È presente un'impugnatura di guida per aiutare a disporre l'utente nella corretta posizione seduta. Questo ausilio è utilizzato solo in fase di sollevamento.

L'imbragatura Molift RgoSling è stata sviluppata per poter essere combinata con una sospensione a 4 punti di fissaggio, ma è ugualmente utilizzabile con una sospensione a 2 punti di fissaggio. Vedere l'elenco di possibili combinazioni per individuare la corretta combinazione tra imbragatura e sospensione.

L'imbragatura Molift RgoSling Comfort Highback è disponibile nelle taglie S – L, in rete di poliestere.

Imbragatura Molift RgoSling Comfort HighBack
Si tratta di un'imbragatura priva di imbottitura che si adatta alla forma del corpo. L'imbragatura deve rimanere sotto all'utente una volta completati sollevamento e spostamento. È realizzata in rete di poliestere che consente la fuoriuscita dell'umidità e del calore del corpo. L'imbragatura può essere applicata soltanto se l'utente è in posizione sdraiata. Le braccia sono posizionate all'interno dell'imbragatura e quest'ultima garantisce una posizione seduta confortevole, supportando pienamente il capo e il corpo.

In condizioni d'uso normali, la vita utile prevista del prodotto è compresa tra 1 e 5 anni. La vita utile del prodotto varia a seconda della frequenza d'uso, dei materiali, dei carichi sollevati e della frequenza di lavaggio.

- A1. Etichetta prodotto
- A2. (01) Codice EAN
xxxxxxxxxxxxxxxx
- (21) Numero di serie
xxxxxxx
- A3. Codice QR
- A4. Etichetta: Ispezione periodica
- A5. Etichetta: Nome utente
- A6. Passante della cinghia superiore
- A7. Impugnatura di guida, lato
- A8. Passanti delle cinghie inferiori
- A9. Simbolo: Leggere il manuale prima dell'uso
- A10. Simbolo: Peso massimo dell'utente
- A11. Simbolo: Questo lato del prodotto va girato verso l'alto e verso l'esterno
- A12. Simbolo: Aprire per maggiori informazioni

Pulizia/lavaggio

Leggere le istruzioni per la pulizia riportate sul prodotto.

1. Le imbragature lavabili possono essere lavate a temperature comprese tra 60 e 85° C.



Eventuali lavaggi a temperature superiori accelerano l'usura dei materiali..

2. Asciugatura in asciugatrice, max 45° C. Lavabili in autoclave a 85 gradi per 30 minuti.
3. Non lavare a secco.
4. Non candeggiare.
5. Non stirare.

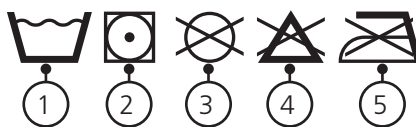

Simboli:



Produttore



Questa parte in alto, questo lato all'esterno



Data di produzione.
AAAA-MM-GG (anno/
mese/giorno)



max 255 kg max 560 lbs
Peso massimo utente



Marchatura CE



Dispositivo medico



Fare riferimento al manuale per l'utente

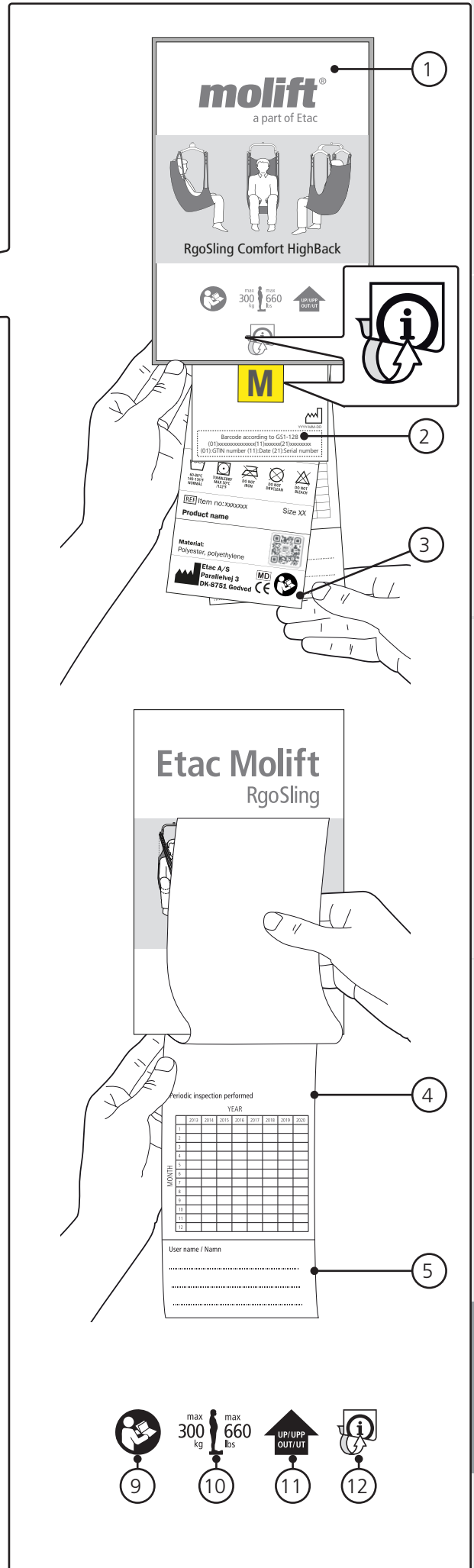
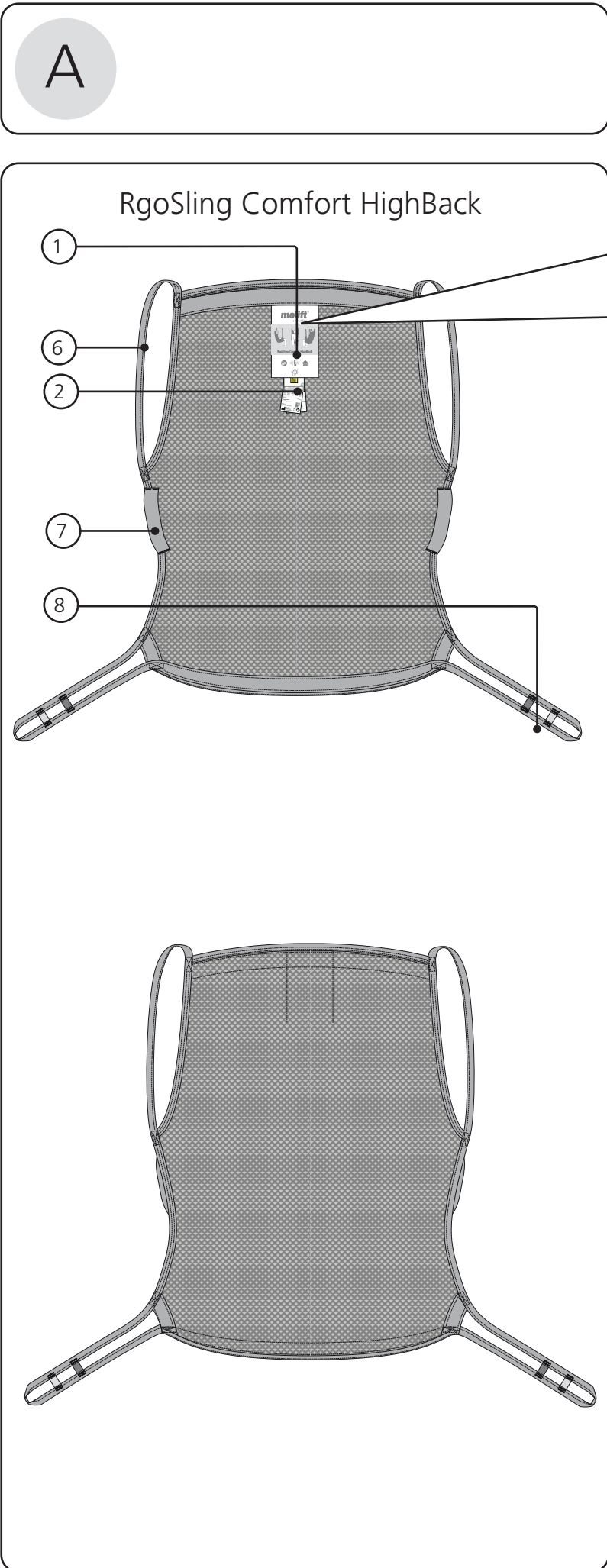

B

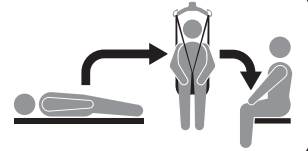

Applicazione dell'imbragatura

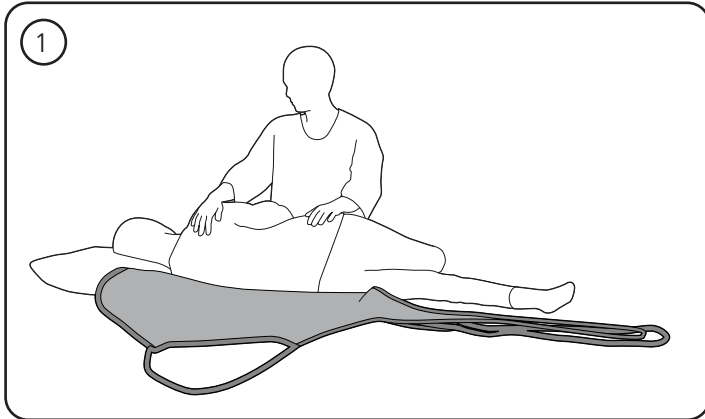

B1. Girare l'utente verso di sé finché non è coricato di lato in posizione sicura. Piegarlo l'imbragatura al centro e posizionarla dietro la schiena dell'utente.

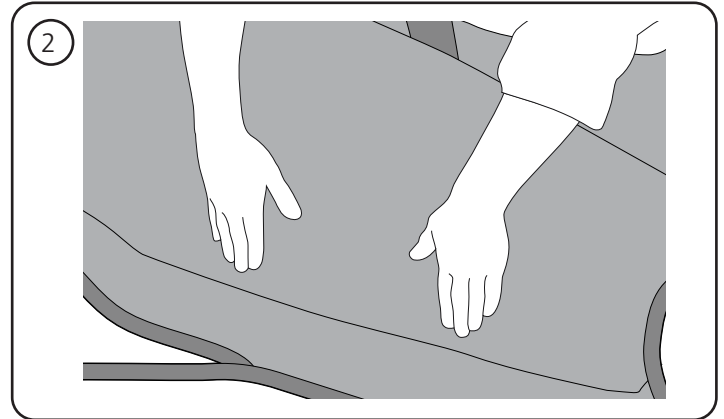

B2. In seguito girare l'utente sul lato opposto e tirare l'imbragatura in avanti. Accertarsi che l'utente sia posizionato al centro dell'imbragatura. Per aiutarsi nell'operazione è possibile utilizzare il poggiaschiena del letto (se presente). Prestare attenzione quando si riposiziona l'utente sull'altro lato. Accertarsi che non si rovesci e non cada dal

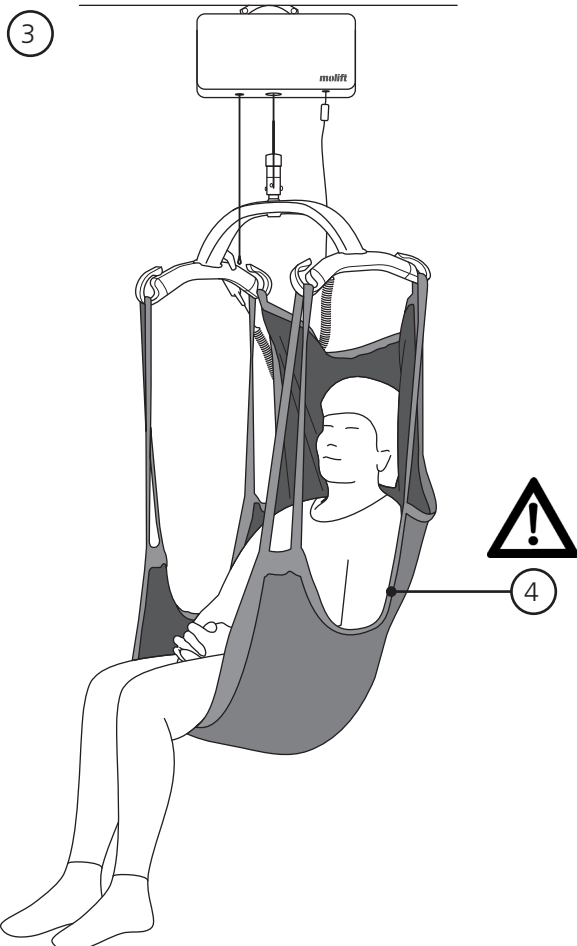

B3. Non incrociare il supporto per le gambe. Se l'utente è instabile in corrispondenza del busto o è spastico (contrazioni muscolari involontarie), cadere di testa dall'imbragatura potrebbe rappresentare un rischio. In tal caso si raccomanda una posizione che sia la più reclinata possibile, utilizzando i punti di collegamento interni delle cinghie di sollevamento inferiori.

B4. È presente un'impugnatura di guida per aiutare a disporre l'utente nella corretta posizione seduta. Questo ausilio è utilizzato solo in fase di sollevamento. Non è un passante per la cinghia da utilizzare per il sollevamento!

Sollevamento

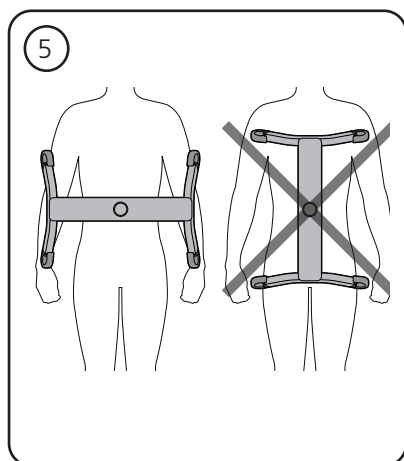

B5. La sospensione deve sempre essere posizionata orizzontalmente, in modo tale da impedire che l'utente scivoli accidentalmente fuori dall'imbragatura.

B6. Assicurare l'imbragatura ai ganci di sospensione.

B7. Tirare le cinghie senza sollevare l'utente. Accertarsi che l'imbragatura sia correttamente

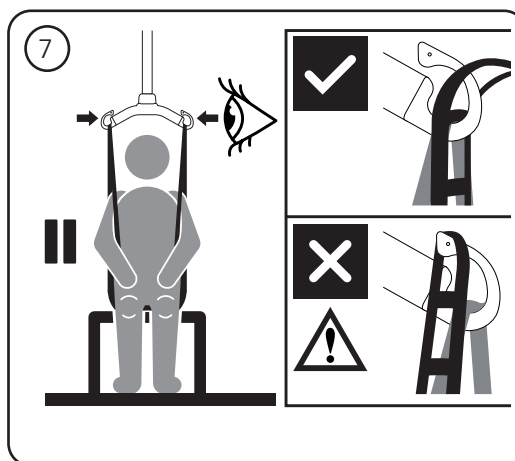
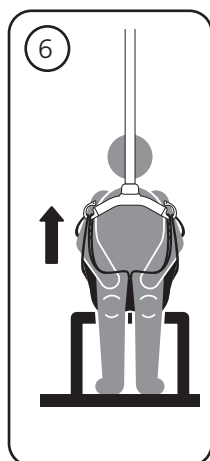

fissata attorno all'utente e che i passanti delle cinghie siano correttamente assicurati ai ganci di sospensione.

B8. Non sollevare l'utente più in alto del necessario. Attenzione: NON bloccare mai le ruote dei dispositivi di sollevamento mobili.

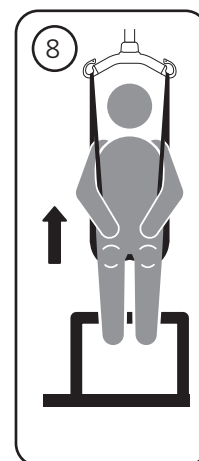

Abbassamento in posizione seduta

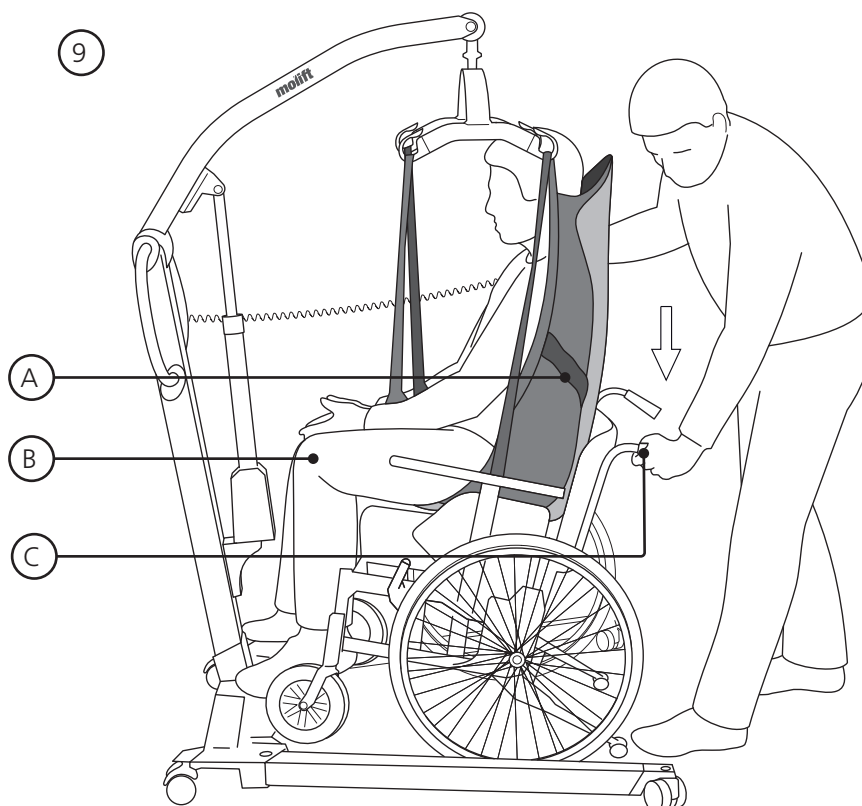

B9. Quando si trasferisce l'utente in posizione seduta, durante l'abbassamento è possibile utilizzare le tecniche seguenti per far sedere l'utente il più indietro possibile:

A. Posizionare l'utente aiutandosi con l'apposita impugnatura

B. Premere delicatamente sulle ginocchia dell'utente

C. Inclinare la sedia all'indietro

C

Regolazione dell'imbragatura e punti di controllo

RgoSling Comfort HighBack

C1. Accertarsi che la sospensione sia tenuta lontana dal viso dell'utente.

C2. Assicurarsi che il supporto per il capo non sia troppo basso, l'imbragatura deve essere posizionata più in alto rispetto alla testa dell'utente.

C3. Assicurarsi che l'imbragatura sia posizionata sotto le cosce.

C4. Non incrociare i passanti delle cinghie inferiori

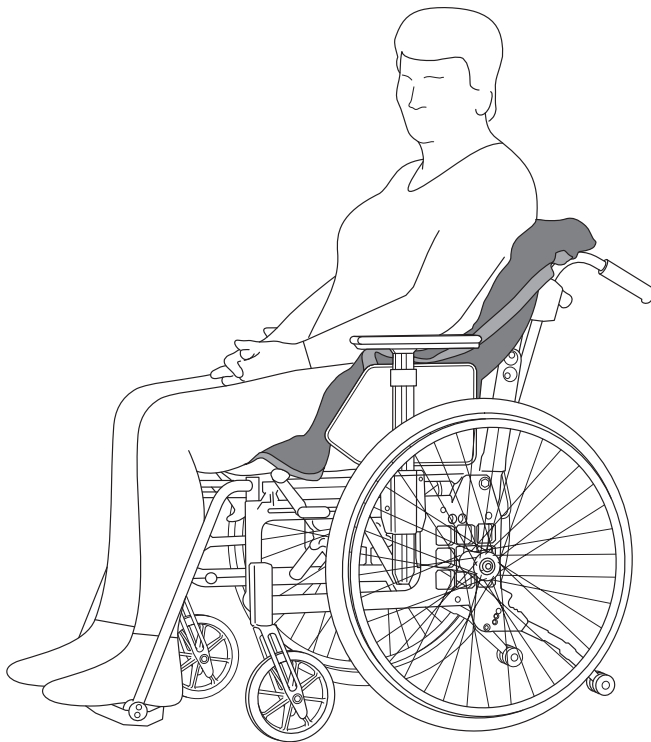
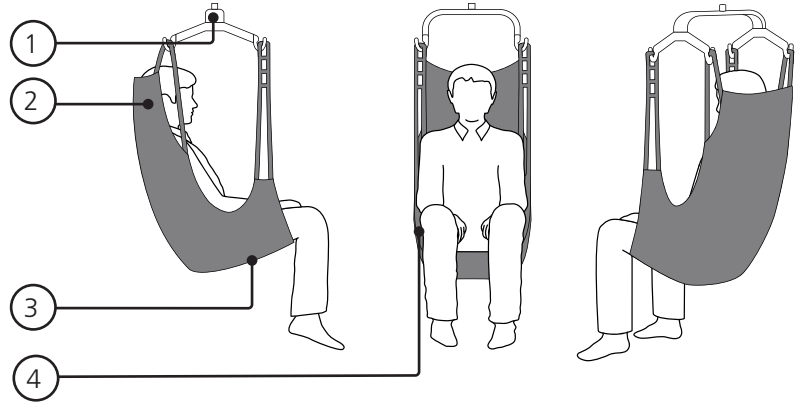

C5. L'imbragatura deve rimanere sotto all'utente dopo il trasferimento.



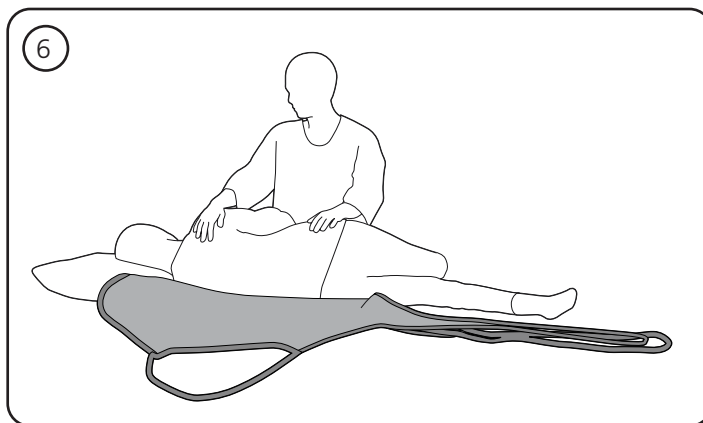





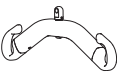

Rimozione dell'imbragatura

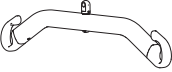

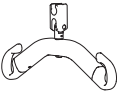
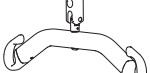
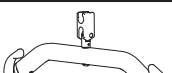

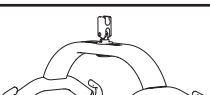

C6. Rilasciare i passanti dalla sospensione. Girare l'utente verso di sé finché non è coricato di lato in posizione sicura. Piegare l'imbragatura al centro e posizionarla dietro la schiena dell'utente. In seguito girare l'utente sul lato opposto ed estrarre

l'imbragatura. Prestare attenzione quando si riposiziona l'utente sull'altro lato. Accertarsi che non si rovesci e non cada dal letto.

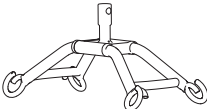
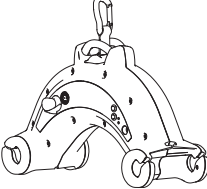
Elenco delle possibili combinazioni

Sospensione		RgoSling Comfort HighBack		
		S	M	L
Mover 180				
	2-pt Small	✓		
	2-pt Medium	✓	✓	
	2-pt Large		✓	✓
	4-pt Medium	✓	✓	✓
	4-pt Large		✓	✓
Mover 205				
	2-pt Small	✓		
	2-pt Medium	✓	✓	
	2-pt Large		✓	✓
	4-pt Medium	✓	✓	✓
	4-pt Large		✓	✓
Mover 300				
	4-pt Medium	✓	✓	✓
	4-pt Large		✓	✓
Partner 255				
	4-pt Medium	✓	✓	✓
	4-pt Large		✓	✓

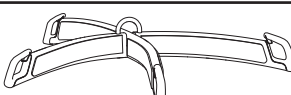
Sospensione		RgoSling Comfort HighBack		
		S	M	L
Smart				
	4-pt Medium	✓	✓	✓
Nomad				
	4-pt Medium	✓	✓	✓
Nova				
	2-pt Small	✓		
	2-pt Medium	✓	✓	
	2-pt Large		✓	✓
	4-pt Medium		✓	✓
	4-pt Large			✓

Guida dell'imbragatura

The size to choose depends partly on the user's weight, function and body circumference/size. SWL (Safe Working Load) is 300 kg.

Risoluzione dei problemi

Problema	Possibile causa/rimedio
L'utente non riesce a indossare bene l'imbragatura.	La taglia dell'imbragatura non è quella giusta. Provare un'altra taglia.
	L'imbragatura è troppo piccola quando i supporti gambe non arrivano alla metà del lato interno della coscia e quando la sospensione è troppo vicina al viso dell'utente. Provare un'altra taglia.
	L'imbragatura non è posizionata correttamente. Tirare l'imbragatura sufficientemente verso il basso lungo la schiena.
Le cinghie non sollevano il carico in maniera uniforme tra loro.	Se le cinghie dell'imbragatura non sollevano il carico in modo uniforme, l'imbragatura rischia di risalire sulla schiena e di far scivolare l'utente attraverso l'apertura. Accertarsi che i supporti gambe siano correttamente posizionati sulle cosce.

EN

SV

NO

DA

FI

DE

NL

FR

IT

ES

Manual en español

Contenido

Recomendaciones generales	94
Medidas de seguridad	94
Medidas de seguridad	95
Inspección	95
Inspección periódica	95
Descripción	96
Etac Molift RgoSling Comfort HighBack	96
Cuidados / lavado	96
Aplicación de la eslinga	97
Elevación.....	98
Descenso del usuario hasta la posición de sentado.....	98
Ajuste de la eslinga y puntos de control ...	99
Retirada de la eslinga.....	100
Lista de combinación.....	101
Guía de eslingas	102
Solución de problemas	103

Prueba y garantía

CE de que este producto cuenta con el marcado CE.

Las eslingas Molift de Etac son comprobadas por institutos de ensayos acreditados y cumplen los estándares descritos en la Directiva de productos sanitarios para productos de Clase 1 MDR (EU) 2017/745. Las eslingas cumplen los requisitos especificados en la norma EN ISO 10535.

Garantía: dos años para defectos de material y fabricación con un uso correcto.

Para más detalles sobre la gama de eslingas y grúas Molift de Etac, visite www.molift.com.

Recomendaciones generales

Gracias por haber escogido una eslinga Molift de Etac.

Es necesario leer el manual detenidamente para evitar daños durante el manejo y utilización del producto.

En este manual, se entiende por «usuario» la persona que es elevada. «Asistente» es la persona que opera la eslinga.



Este símbolo aparece en el manual junto con texto. Indica la necesidad de precaución cuando la seguridad del usuario o del asistente pueda estar en riesgo.

Etac realiza continuas mejoras en sus productos. Por esta razón, nos reservamos el derecho de realizar cambios en los productos sin previo aviso.



Visite www.molift.com para obtener más información, consejos y actualizaciones de documentación.

No nos hacemos responsables de errores de imprenta u omisiones.

Medidas de seguridad



Es necesario leer detenidamente el manual tanto para grúas como para eslingas antes de su uso para evitar lesiones durante el manejo y utilización del producto.

Es importante que la eslinga se haya probado con el usuario y para la situación de elevación prevista. Decida si son necesarios uno o más asistentes.

Planifique la elevación de forma anticipada para garantizar que discurre de forma tan segura y fluida como sea posible. Recuerde trabajar de forma ergonómica.

Evalúe los riesgos y tome notas de los mismos. Como cuidador, usted es responsable de la seguridad del usuario.



No eleve nunca a un usuario más de lo necesario por encima del punto de partida para llevar a cabo una elevación. Nunca deje al usuario sin supervisión cuando lo esté elevando



Compruebe siempre que el usuario posee la capacidad necesaria para la eslinga en cuestión

- El modelo, tamaño y material son adecuados
- La eslinga es adecuada para la grúa / percha que se va a utilizar.
- Es importante comprobar que los lazos de las correas están correctamente atados a los ganchos de la percha antes de elevar al usuario.
- Asegúrese de que las ruedas de la silla de ruedas, cama o litera están bloqueadas cuando sea necesario durante el proceso de traslado.

Inspección

La eslinga debe inspeccionarse periódicamente, preferiblemente antes de cada elevación, pero, sobre todo, después de haberse limpiado.

- Compruebe que no hay desgaste ni daños en costuras, tela, correas y lazos.



No utilice nunca una eslinga defectuosa o dañada porque puede romperse y provocar lesiones personales. Destruya y deseche las eslingas viejas y dañadas.



La eslinga no debería guardarse expuesta a la luz solar directa.

Inspección periódica

La inspección periódica debe llevarse a cabo como mínimo cada 6 meses. En ocasiones pueden ser necesarias inspecciones más frecuentes si la eslinga se utiliza o se lava más a menudo de lo habitual. Consulte el formulario de inspección periódica en www.molift.com

EN

SV

NO

DA

FI

DE

NL

FR

IT

ES

Descripción

Molift de Etac ofrece una amplia gama de eslingas para diferentes tipos de traslados. Molift RgoSling de Etac se ha diseñado para ofrecer una relación uniforme entre el peso y la carga lo más cómoda posible.

Las correas de suspensión de la parte superior de la parte superior de la eslinga son deslizables, lo que permite encontrar un equilibrio homogéneo durante toda la transferencia, proporcionando al usuario una gran comodidad y una elevación placentera

Hay un asa guía que ayuda a colocar a los usuarios en la posición sentada correcta y se utiliza solo cuando los usuarios se hallan en modo de elevación.

La eslinga Molift RgoSling de Etac se ha desarrollado para combinarse con un percha de 4 puntos pero también funciona con una percha de 2 puntos. Consulte la lista de combinación para la combinación correcta entre eslinga y percha.

Molift RgoSling Comfort Highback está disponible en los tamaños S – L, en malla de poliéster.

Molift RgoSling Comfort HighBack

Es una eslinga sin acolchado que se amolda al cuerpo. La eslinga está destinada a permanecer bajo el usuario una vez finalizados la transferencia y el movimiento. Está hecha de una malla de poliéster que permite la transpiración del calor y la humedad corporal. La eslinga se puede colocar únicamente con el usuario colocado en posición tumbada. Los brazos se colocan dentro de la eslinga, que proporciona una posición sentada cómoda con una sujeción total de la cabeza y el cuerpo.

El producto tiene una vida útil prevista de 1 a 5 años en condiciones de uso normales. La vida útil del producto depende de la frecuencia de uso, de los materiales, de las cargas y de la frecuencia con la que se lava.

- A1. Etiqueta del producto
- A2. (01) Código EAN
xxxxxxxxxxxxxxxx
- (21) Número de serie
xxxxxxx
- A3. Código QR
- A4. Etiqueta: Inspección periódica
- A5. Etiqueta: Nombre de usuario
- A6. Lazos de las correas superiores
- A7. Asa guía, lateral
- A8. Lazos de las correas inferiores
- A9. Símbolo: lea el manual antes de su uso
- A10. Símbolo: peso máximo del usuario
- A11. Símbolo: este lado del producto apunta hacia arriba y hacia afuera
- A12. Símbolo: desplegar para más información

Cuidados / lavado

Lea las instrucciones de cuidado del producto.

1. Las eslingas que puedan lavarse con agua deberán lavarse a una temperatura entre 60 y 85 °C.
-  El lavado a temperaturas más altas desgasta el material más rápidamente.
2. Secado en secadora, máx. 45 °C. Puede esterilizarse en autoclave a 85 °C durante 30 minutos.
 3. No lavar en seco
 4. No utilizar lejía
 5. No planchar.

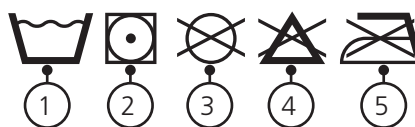

Simboli:



Produttore



Data di produzione.
AAAA-MM-DD
(anno/mese/día)



Marchio CE



Fare riferimento al manuale dell'utente



Lato alto,
lato esterno



Peso massimo utente
(carico di sicurezza)



Dispositivo medico

A

RgoSling Comfort HighBack

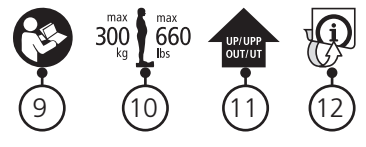
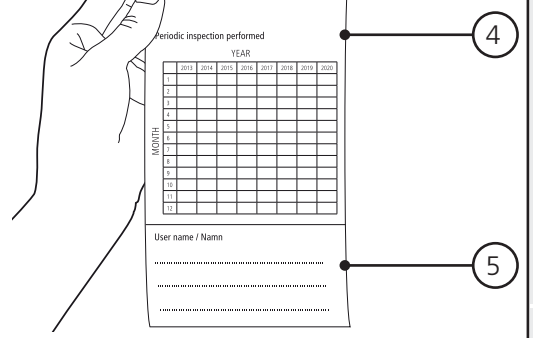
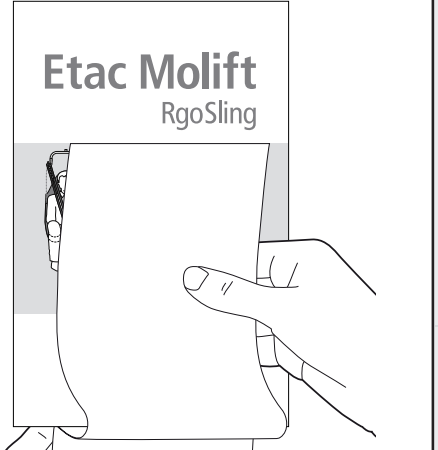
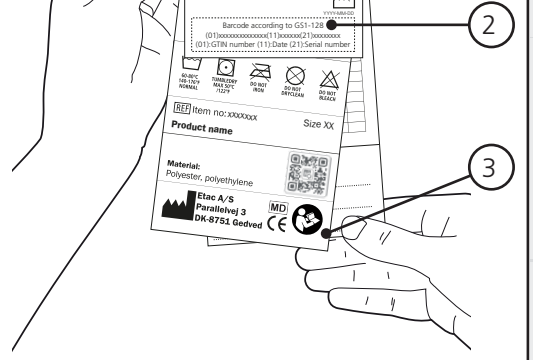
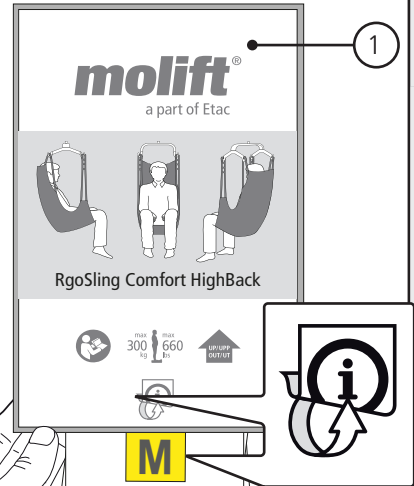
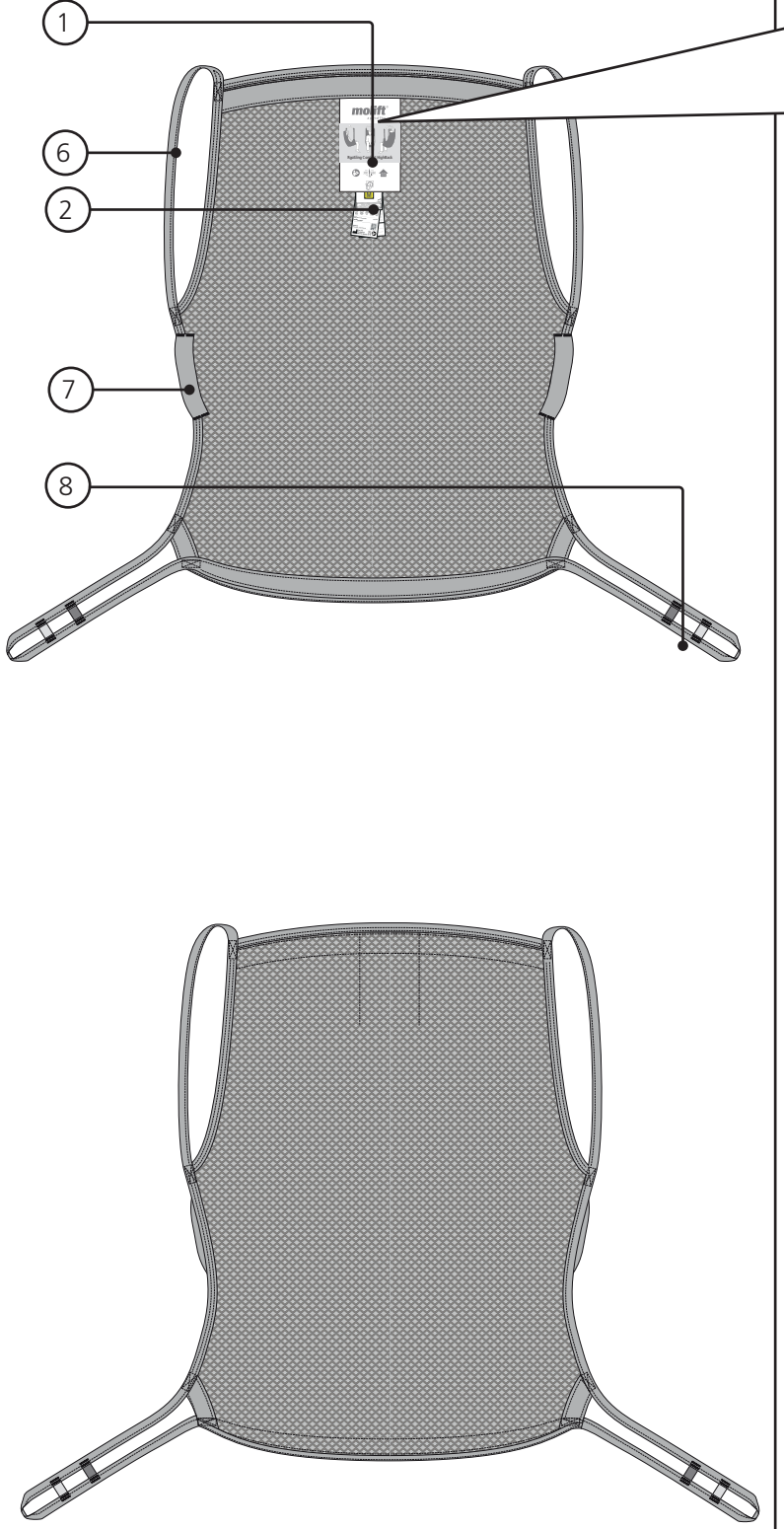

B

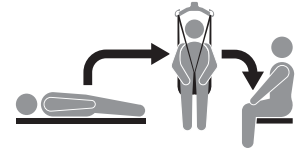

Aplicación de la eslinga

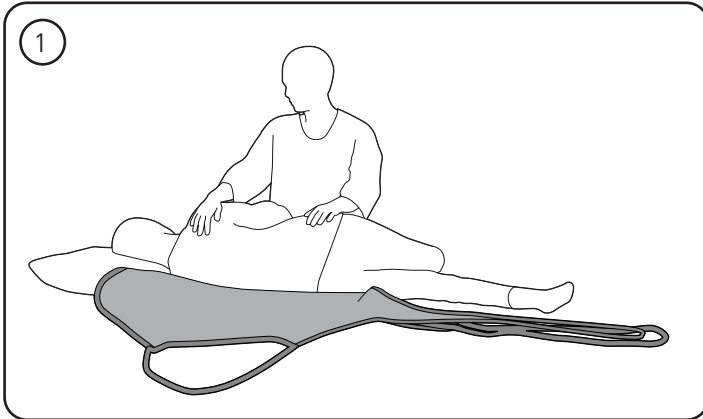

B1. Gire al usuario hacia usted hasta que esté tumbado de forma segura sobre su costado. Doble la eslinga y colóquela detrás de la espalda del usuario.

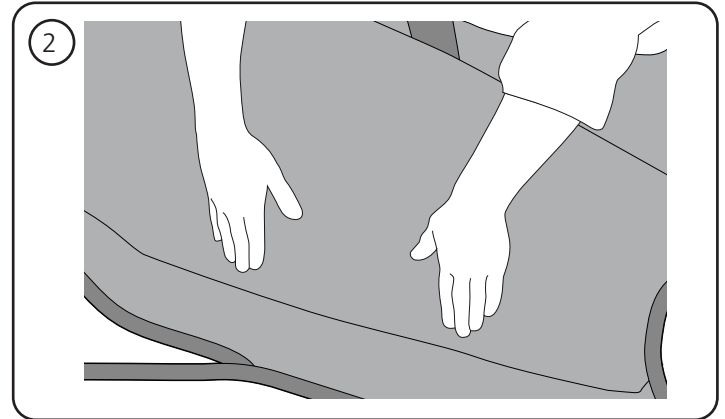

B2. A continuación, gire al usuario hacia el lado opuesto y tire de la eslinga hacia delante. Asegúrese de que el usuario está colocado en el centro de la eslinga. Si la cama cuenta con un soporte posterior, puede utilizarlo. Tenga cuidado al volver a colocar al usuario en el otro lado. Asegúrese de que no se da la vuelta y se cae de la cama.

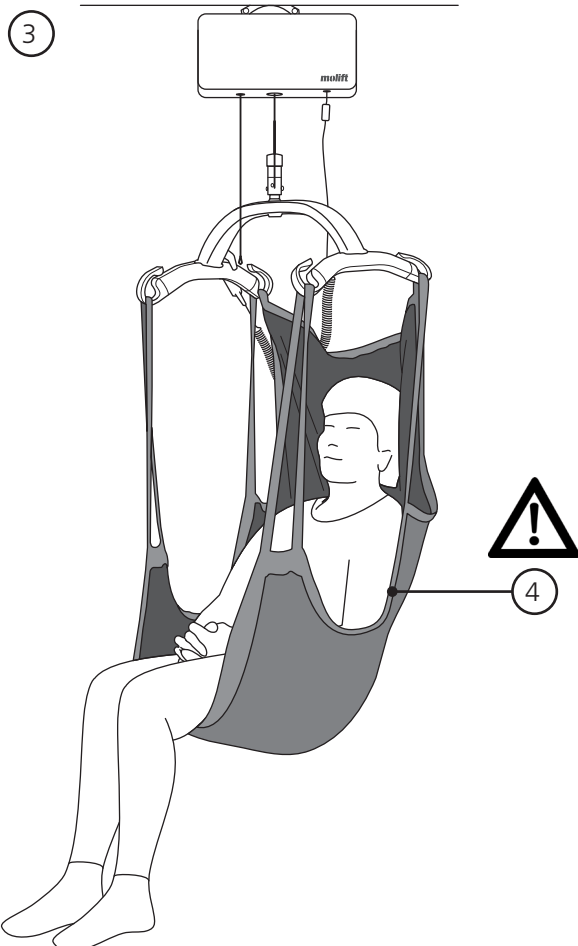

B3. No cruce el soporte de la extremidad. Si el usuario no tiene estabilidad en el torso, o si es espástico (contracciones musculares involuntarias), puede existir el riesgo de que se caiga de cabeza fuera de la eslinga. En este caso, recomendamos una posición lo más reclinada posible, utilizando los puntos de conexión internos en las correas de elevación inferiores.

B4. Hay un asa guía que ayuda a colocar a los usuarios en la posición sentada correcta y se utiliza solo cuando los usuarios se hallan en modo de elevación. Esto no es un lazo de correa para elevación.

Elevación

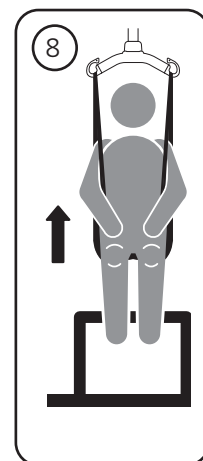
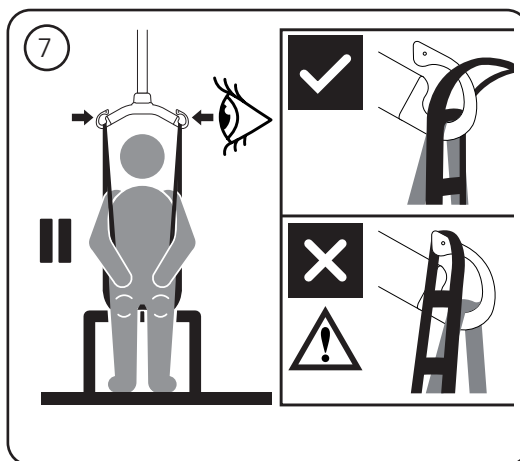
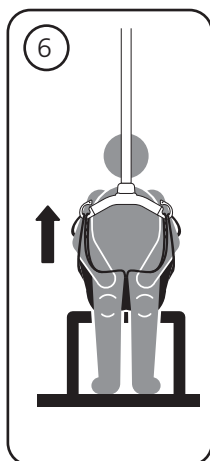
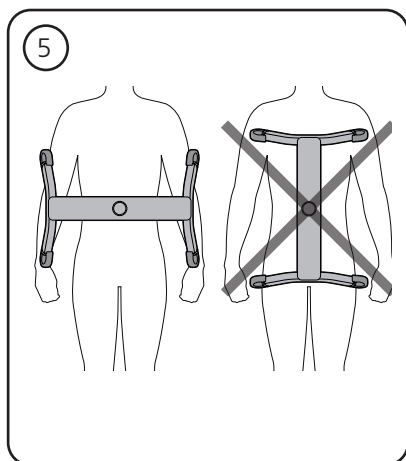

- B5. La percha debe colocarse siempre cruzada sobre el usuario para evitar que este se salga accidentalmente de la eslinga.
- B6. Suspenda la eslinga en los ganchos de la percha.
- B7. Estire las correas de la eslinga sin elevar al usuario. Compruebe que la eslinga está correcta-

- mente colocada alrededor del usuario y que los lazos de las correas están correctamente colocados en los ganchos de la percha.
- B8. No eleve al usuario más de lo necesario. Recuerde que las ruedas de una grúa móvil NO deben estar bloqueadas.

Descenso del usuario hasta la posición de sentado

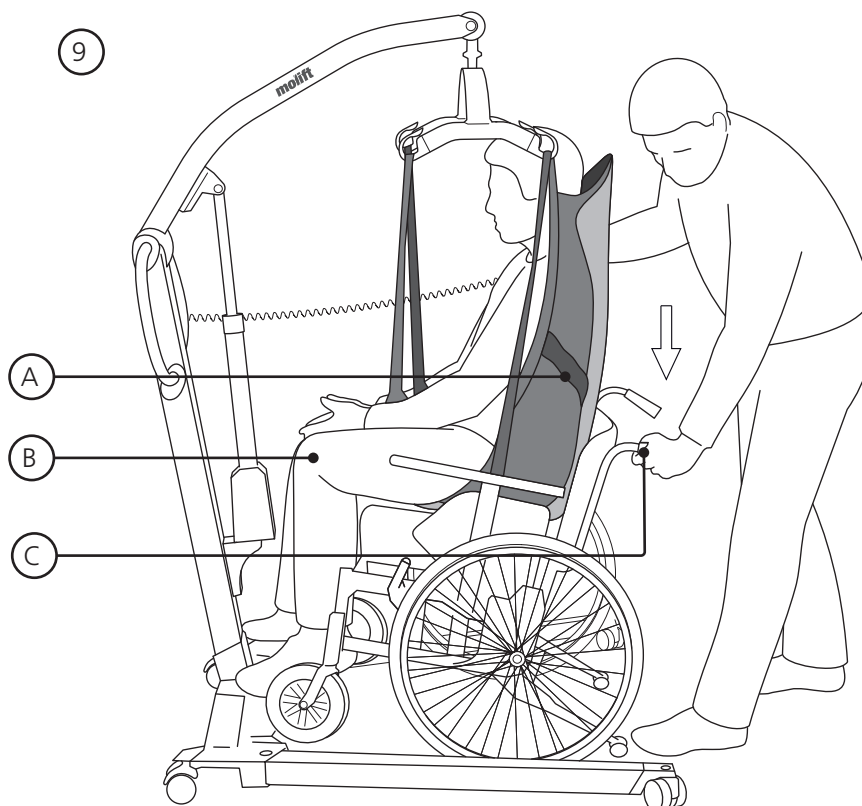

- B9. Cuando se traslada el usuario a la posición de sentado, pueden utilizarse las siguientes técnicas cuando se descienda al usuario hacia la parte más posterior del asiento posible:

- A. Coloque al usuario ayudándose del asa de dirección.
- B. Presione suavemente sobre las rodillas del usuario.
- C. Inclíne el asiento hacia atrás.

C

Ajuste de la eslinga y puntos de control

RgoSling Comfort High-

- C1. Asegúrese de que la percha está alejada de la cara del usuario.
- C2. Asegúrese de que el reposacabezas no está demasiado bajo, la eslinga debería colocarse por encima de la cabeza del usuario.
- C3. Asegúrese de que la eslinga está bien colocada bajo los muslos.
- C4. No cruce los lazos de las correas inferiores.

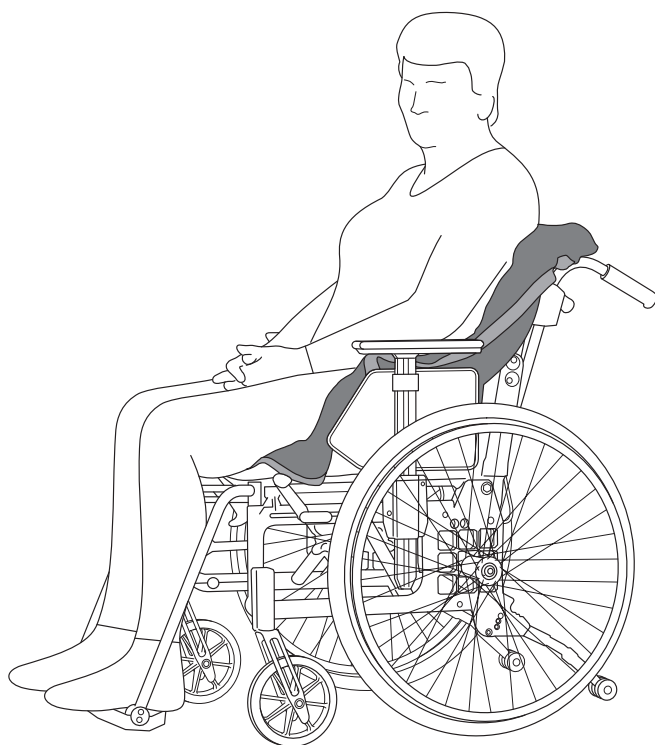
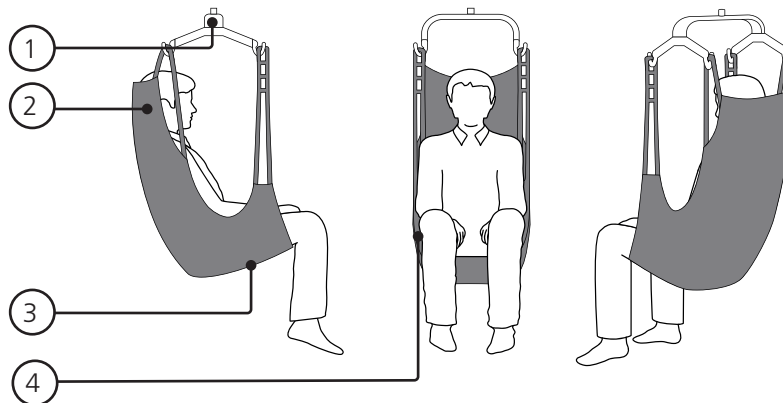

- C5. La eslinga debe permanecer bajo el usuario tras el traslado.



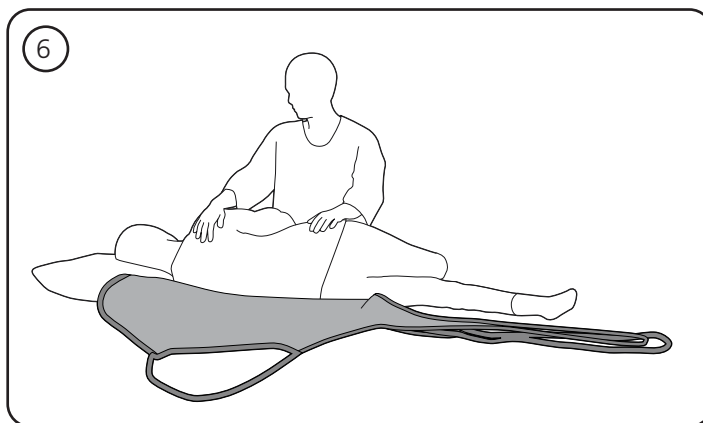





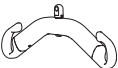

Retirada de la eslinga



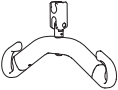
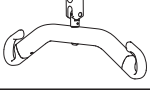
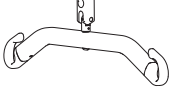



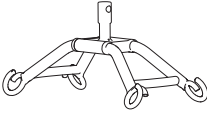
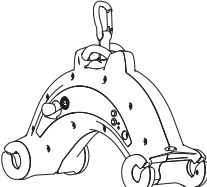

C6. Libere los lazos de la percha. Gire al usuario hacia usted hasta que esté tumbado de forma segura sobre su costado. Doble la eslinga por la mitad y colóquela detrás de la espalda del usuario.

A continuación, gire al usuario hacia el lado opuesto y tire de la eslinga. Tenga cuidado al volver a colocar al usuario en el otro lado. Asegúrese de que no se da la vuelta y se cae de la cama.

Lista de combinación

Percha		RgoSling Comfort HighBack		
		S	M	L
Mover 180				
	2-pt Small	✓		
	2-pt Medium	✓	✓	
	2-pt Large		✓	✓
	4-pt Medium	✓	✓	✓
	4-pt Large		✓	✓
Mover 205				
	2-pt Small	✓		
	2-pt Medium	✓	✓	
	2-pt Large		✓	✓
	4-pt Medium	✓	✓	✓
	4-pt Large		✓	✓
Mover 300				
	4-pt Medium	✓	✓	✓
	4-pt Large		✓	✓
Partner 255				
	4-pt Medium	✓	✓	✓
	4-pt Large		✓	✓

Percha		RgoSling Comfort HighBack		
Smart		S	M	L
	4-pt Medium	✓	✓	✓
Nomad				
	4-pt Medium	✓	✓	✓
Nova				
	2-pt Small	✓		
	2-pt Medium	✓	✓	
	2-pt Large		✓	✓
	4-pt Medium		✓	✓
	4-pt Large			✓

Guía de eslingas

El tamaño en cuestión dependerá en parte del peso del usuario, de su actividad y de la circunferencia y el tamaño de su cuerpo.

Carga de trabajo segura (SWL): 300 kg.

Solución de problemas

Problema	Causa / acción posibles
La eslinga no se adapta al usuario.	Tamaño de la eslinga incorrecto. Pruebe otro tamaño.
	La eslinga es demasiado pequeña cuando los soportes de las extremidades no alcanzan la mitad del muslo interno y la percha está demasiado cerca de la cara del usuario. Pruebe otro tamaño.
	La eslinga no está bien colocada. Tire de la eslinga suficientemente hacia abajo en la parte posterior cuando la coloque.
Las correas no elevan al mismo tiempo.	Si las correas de la eslinga se elevan de manera desigual, significa que la eslinga puede deslizarse hacia arriba en la parte posterior, lo que puede hacer que el usuario se resbale por la apertura de la eslinga. Asegúrese de que los soportes de las extremidades están colocados correctamente en los muslos.

EN

SV

NO

DA

FI

DE

NL

FR

IT

ES



Etac A/S
Parallevej 3
DK-8751 Gedved
www.etac.com



molift[®]
by Etac